

VOTRONIC

Installation and Operating Manual

VPC Jupiter 100 with Measuring Shunt 100 A

No. 5747

VPC Jupiter 200 with Measuring Shunt 200 A

No. 5748

VPC Jupiter 400 with Measuring Shunt 400 A

No. 5749

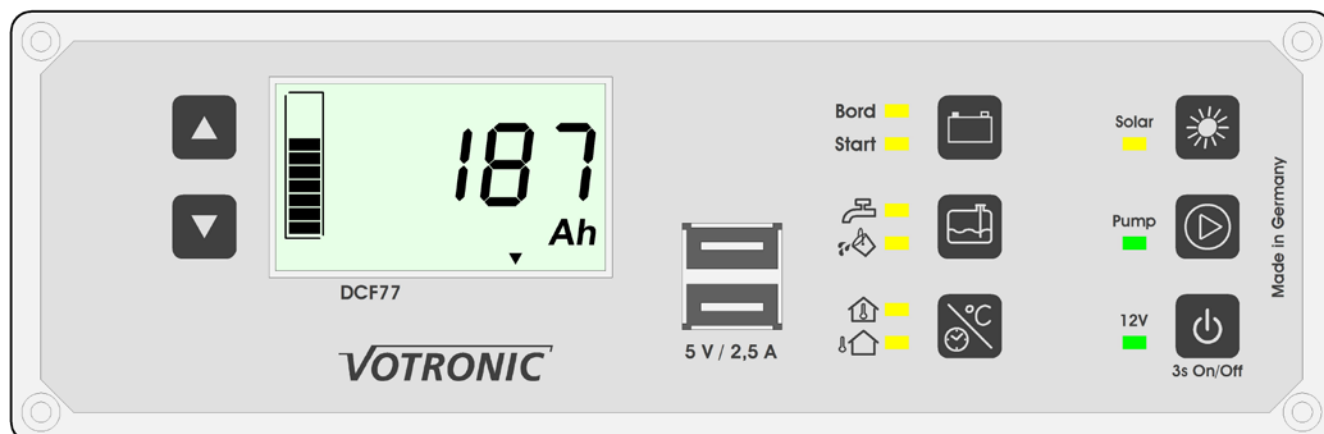

The VPC Jupiter (hereinafter referred to as Jupiter) is a user-friendly multi-panel system for campers combining the most important functions and information in one unit.

The VPC Jupiter consists of a display and control panel, as well as of the smart shunt for current measurement and evaluation of the residual battery capacity.

It is equipped with a dual USB charging jack with a maximum charging current of 2.5 A for appliances which can be charged via USB, such as smartphones or tablets.



Battery Computer for the Board Battery

Voltage in V

Battery current in A

Battery capacity in % and Ah

Remaining time in h

Undervoltage protection

Voltage of the starter battery in V



Solar computer

Suitable for all VOTRONIC Solar Charging Controllers (also VBCS Tripe) from year of construction 2014

Instantaneous solar power in W

Instantaneous solar current in A

Charged solar capacity in Ah

Charged solar power in kWh



Level indicator

Level fresh water and sewage water tank in %



Pump Switch

Switch for fresh water pump max. 16 A (potential-free output)



Thermometer/clock

Inside temperature/outside temperature in °C, including 2 temperature sensors

Time in 24 hours format



Main switch function

Main switch for board supply via terminal 0.3 A

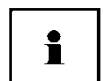



Please read the operating manual and the safety regulations completely prior to start-up of the system.

Operation

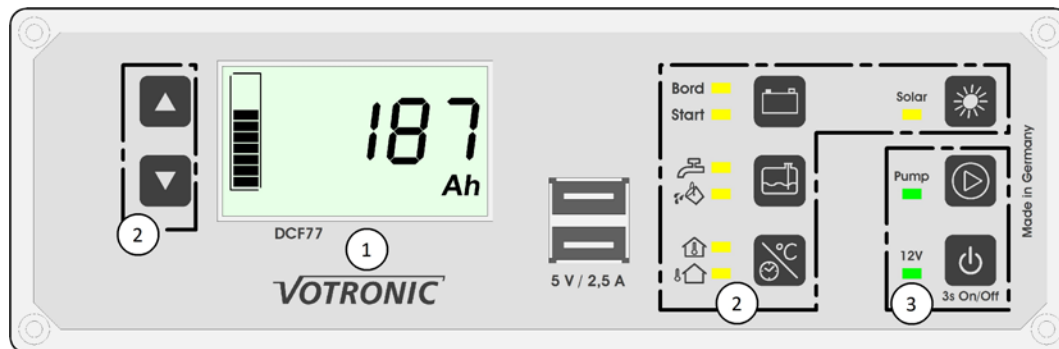
Control and Display Panel



- ① The display shows the actual data (time, level, voltage, ...) as numerical values. The menu level and the displays of the board battery additionally show a bar graph on the left side. The measurement unit of the displayed value is also shown on the display.
- ② The desired information is shown on the display using the control keys of the battery computer, the tank displays, the display units for thermometer or clock and of the solar computer. The adjacent LED indicates the kind of information being currently displayed. To change the display, such as between board battery and starter battery, press the key adjacent to the corresponding LED. In the menus for board battery and solar computer, different values can be displayed consecutively. Use the arrow keys   on the right side of the display to change to the next or previous page.
- ③ Control keys and remote control keys for display ON/OFF, main switch and pump relay. The LED lamps adjacent to the keys indicate the corresponding state.

Display Illumination:



The illumination of the display is activated automatically when pressing any key. It will be turned off automatically after 3 minutes, if the main switch is switched-on. If the main switch is switched-off, the illumination will be turned off already after 20 seconds to avoid an unnecessary load of a possibly empty battery.

The illumination can also be switched-off manually by shortly pressing the main switch (see figure on the left side).

The brightness of the LED lamps is coupled with the illumination of the display. If the display is dark, also the LED lamps will be dimmed to a minimum.

Brightness Display and LED:



The brightness of the display illumination and of the LED lamps can be changed at any time by pressing and holding (3 seconds) the arrows keys. The settings will be kept in memory.

Main Switch:



The main switch will be switched-on or off by pressing and holding the ON/OFF key longer (>3 s). The state of the main switch is indicated by the adjacent LED "12 V". Please observe, that the main switch will be switched-off automatically in case of low battery capacity or voltage (see battery protector).

If the main switch had been switched-off, the illumination will be turned off already after 20 seconds. Operation of water pump and USB charger is only possible, if the main switch had been switched-on. They will be switched-off automatically, as soon as the main switch had been switched-off.

Water Pump:



The pump key switches the pump relay on or off. The state of the relay is indicated by the adjacent LED. Operation of the pump is only possible, if the main switch had been switched-on. It will be switched-off automatically, as soon as the main switch had been switched-off. The pump cannot be switched-on, if the main switch had been switched-off.

Solar Computer:



The Solar Computer indicates the current operating state, the solar current, as well as the solar power of the connected VOTRONIC Solar Controller. In addition, it is equipped with a solar power meter.

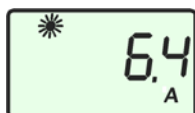

Use the arrow keys on the right side of the display to change to the next or previous page.

Current: The instantaneous current rate in Amperes (A) is displayed.



Capacity: The instantaneous capacity in Watts (W) of the solar system is displayed.

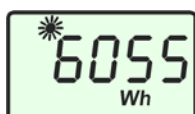

Solar Power Meter: The power being generated by the solar system is measured continuously and will be displayed as ampere-hours (Ah), as well as watt-hours (Wh). If the value 9999 Wh is exceeded, the display changes automatically to kWh. The meter readings can be separately reset to zero at any time. Reset can be effected, if the corresponding meter value is displayed and by pressing the key Solar for more than 3 seconds until (Set ----) is displayed.

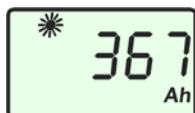

Operating State Solar Controller:

Depending on the solar controller, the operating state of the solar controller is indicated by the sun symbol.

- No sun: Solar power is not at disposal; the solar controller is in stand-by mode.
- Full sun: Solar power is at disposal, maximum possible charge
- Flashing sun: The controller limits the current because of a full or almost full battery to avoid battery overcharging. For determination of the possible solar power, the battery must be discharged by a consumer (such as lighting) until the solar controller stops limiting the current and the sun symbol stops flashing.

Thermometer/Clock:



The thermometers indicate the inside and outside temperature.

Press the key "Thermometer/Clock" to change between inside and outside temperature or clock.

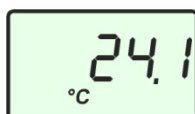

The time is displayed in 24 hours format.

Setting of the time is effected by pressing the key "Thermometer/Clock" for 3 seconds, until "Set" will be displayed at the upper edge of the display, and the hours of the time will be flashing. Use the arrow keys to set the hours. Shortly press the key "Thermometer/Clock" to set the minutes. The minutes will now be flashing and can be changed using the arrow keys .

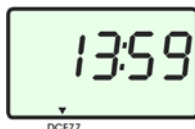

Tank Displays:



The tank displays indicate the levels (level height) of the fresh water and sewage water tank as percentage.

Use the key "Tank" to switch between the display for fresh water tank and sewage water tank. If the sensors had not been connected or are wrongly connected, the corresponding tank display cannot be selected.

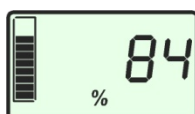

Current will only be supplied to the tank sensors, if the levels will be interrogated by a keystroke. If the illumination of the display is switched-off manually, or if it switches-off itself after a certain time, the display changes automatically to the actual time. Thus, an unintended operation of the sensors and current consumption is avoided.

Battery Computer:

Board 



Start 

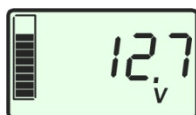

The Battery computer indicates all relevant values of board and starter battery.

Switching from board battery to starter battery and vice-versa is effected by pressing the key "Battery".



Use the arrow keys   on the right side of the display to change to the next or previous page.

Voltage: The display shows the voltage in Volts (V) of the corresponding battery.

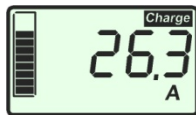

Current: The current display informs about the current load or charge of the battery. The display shows the instantaneously measured current rate in Amperes (A) flowing into or out of the battery. If the current flows into the battery, the display will show a positive current value and the charging symbol "CHARGE". If the current flows out of the battery, it is negative, and the value will be shown with a preceding negative sign.



Residual Capacity: The residual capacity of the board battery will be displayed in ampere-hours (Ah) and as percentage (%). Additionally, it is displayed in form of a bar graph (like a level).

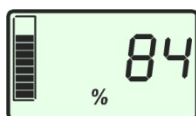

Display of the Remaining Time:

The remaining time will be calculated from the residual capacity (up to the adjusted switching-off threshold) and of the actual current. In case of very high current rates, an adaption to the capacity value of the battery will not be effected. Thus, in case of high current rates, the display of the remaining time is only of informative character.

It is calculated according to the following formula:

$(\text{Capacity switching-off threshold} - \text{actual capacity}) / \text{actual current}$.

If the battery does not supply current, a calculation of the remaining time is, of course, not possible. Now the sign -- will be displayed.

Battery Protector:

Combined with a remote-controlled main switch (e. g. Switch Unit 100), the VPS Jupiter system has an integrated protection against deep discharge which can be adjusted individually.

If the residual capacity drops below the adjusted residual capacity, the main switch (terminal) will be switched-off automatically. It can be switched-on manually at the display panel (see main switch). Additionally, a restart threshold can be set in the menu. As soon as this threshold is exceeded, the main switch will be switched-on automatically. This threshold is factory-adjusted to 101 %, which means that an automatic activation is prevented.

The second protective measure is the disconnection in case of low voltage. If the voltage drops below the adjusted low voltage of, for instance, 10.5 V, for 30 seconds, the main switch will also be switched-off automatically.

If the main switch is disconnected, the pump and the USB charging socket will also be switched-off at the same time.

A short audible alarm signal will be given by the display panel.

Cleaning:

We recommend to use a damp microfibre cloth with pure water or, if required, with water with a few soap. Take care, that no liquid flows along the display screen or the edges of the front panel.



Never use solvents, aggressive household cleaners, and scratching or abrasive agents or objects to clean the front panel and particularly the display itself.

Installation and Connection:

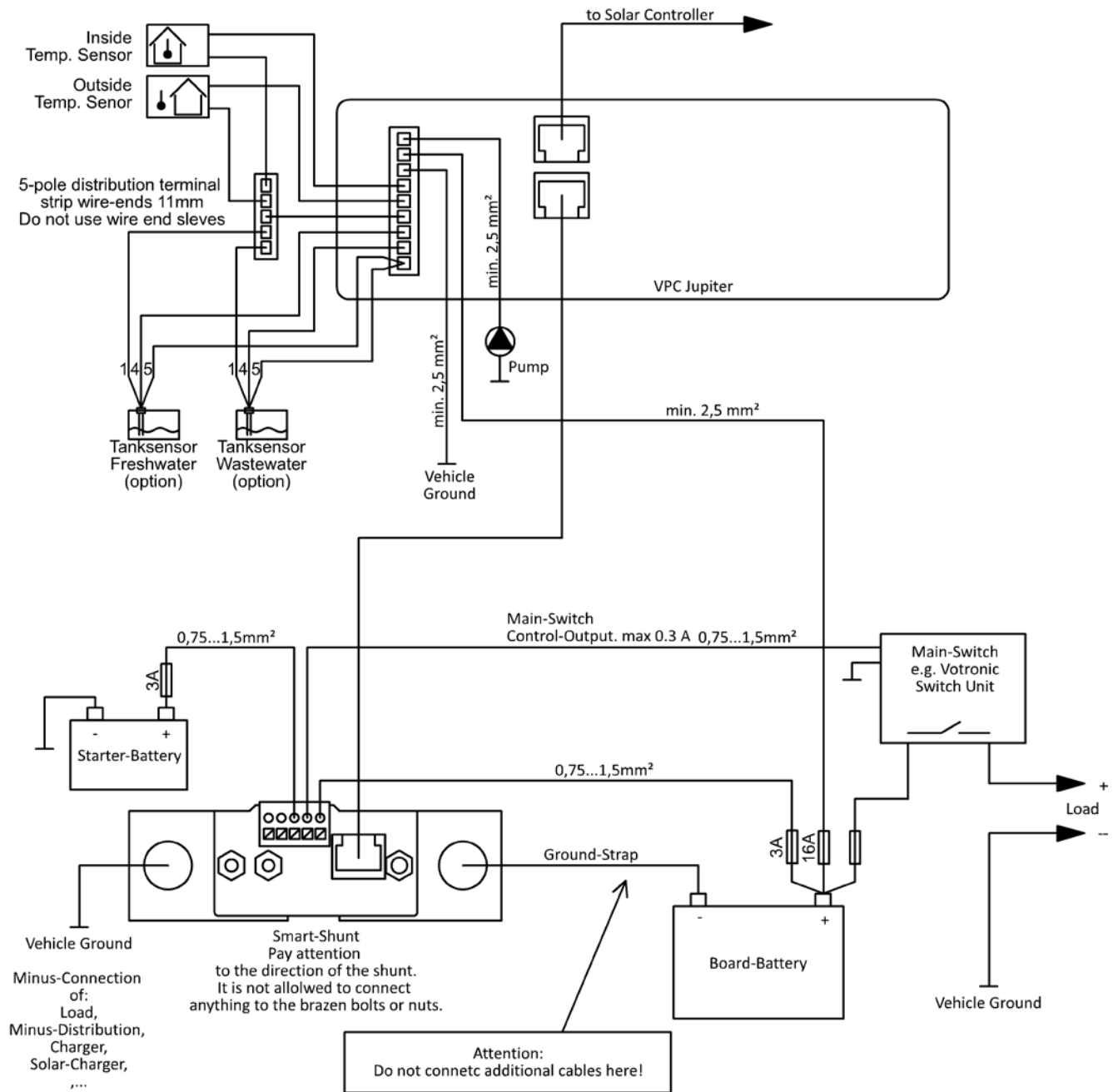

All terminals are designed in such a way, that end-type terminals are not required. The 9-pole terminal at the display panel is a plug-in terminal, which can be removed for installation. The cable cross-sections can be drawn from the plan. Since fuses serve as cable protection, they must be positioned as close as possible to the battery.

Smart Shunt

The smart shunt measures the battery voltage and the current for determination of the residual capacity (level) of the battery. Furthermore, it can measure the voltage of the starter battery, and it is equipped with a terminal for control of a main switching relay, such as the Votronic Switch Unit 40.

Any battery current should flow over the smart shunt. Therefore, it is to be installed directly near the battery (batteries). Correct calculation of the actual battery capacity is only possible, if all currents are detected correctly by the smart shunt.

Ground straps at the connecting screws M8 of the smart shunt are to be screwed in such a way, that one connection is connected to the negative pole of the battery and the other one with the car body. The connections at the negative pole of the battery and at the body / ground should not be mixed up (see connection plan). Otherwise, a charge is measured as discharge and vice-versa.

Never connect anything to the brass screws of the electronic system of the smart shunt.



The connections at the smart shunt should always be tightened firmly to avoid any transition resistance. Permanent high load might result in heating of the smart shunt.

Except of the smart shunt, no further connection (e. g. of consumers or charging devices) should exist at the negative pole of the battery or at the negative pole of the complete battery system!

The terminal of the smart shunt supplies 300 mA and serves for control of a Votronic Switch Unit. These units are relays for high current rates, which do not require any current for holding, thus avoiding an unnecessary load of the battery. Remote control of the terminal is effected from the panel. Thus, it can be switched-off and switched-on manually. Furthermore, an automatic disconnection is possible, when dropping below the adjusted residual capacity or battery voltage (protection against deep discharge).

Display and Control Panel (Display Panel)

Choose a central and easily accessible location in the living area for installation of the display panel. This will facilitate the legibility of the information and the operation of the functions. The clear width of the cutout is at least 184 x 57 mm.

If possible, the rear cutout opening should be covered with electrically nonconducting material to ensure efficient protection of the electronic system and full utilization of the storage space, which might be located behind. Ensure the ventilation of the electronic system.

The display panel will be connected to the smart shunt via a 6-pole control cable. The connection is executed ready to be plugged in, and the cable should be laid according to the safety instructions.

Supply of the display panel including USB charging socket and pump relay is effected directly from the battery. The temperature sensors, as well as the optional tank sensors use the delivered 5-pole distribution terminal as common minus connection. For this terminal, the wire-ends must be stripped for a length of 11 mm.

Water Pump

The relay contact for the water pump is switched by a key at the display. The maximum admissible load of the output is 16 A.

Outside Temperature Sensor

Install the delivered temperature sensor for outside temperature at a protected location, if possible below the vehicle. Ensure that the installation place is not influenced by any source of heat (hot exhaust, asphalt etc.). Should the length of the connection cable at the temperature sensor be not sufficient, it can be extended to the desired length by a cable of min. 0.75 mm².

The temperature sensors are protected against reverse battery and can be connected with any polarity.



Inside Temperature Sensor

For installation, remove the cap from the temperature sensor and insert the sensor with the cable from behind through the mounting hole (7.5 mm). Reinsert the cap on the sensor after that and push both into the mounting hole from the front. The temperature sensors are protected against reverse battery and can be connected with any polarity.



Tank Sensors

As option, up to two Votronic Tank Sensors can be connected and used. All Votronic Tank Sensors of the product category "Mobile Leisure Time" are compatible. The connections of the tank sensors are to be coupled to the display panel, as indicated in the connection plan. The cross-section of the cables should be min. 0.75 mm². The current supply to the tank sensors by the panel is restricted to the time, in which the levels are interrogated.

Solar Controller

As option, a Votronic Solar Controller from model 2014 can be connected to the panel by means of a 6-pole control cable.

Initial Start-up

The smart shunt is ready for operation, as soon as all electric connections at the smart shunt and the display panel are made. Besides, the following basic settings must be made compulsory.

Basic Setting:

- The nominal capacity of the board battery must be set.
- The used battery type and its nominal voltage must be set.
- The switching-off thresholds and switching-on thresholds can be adapted.
- The audible alarm can be deactivated.
- The actual time must be set.

The nominal capacity is indicated in Ah, and it is imprinted on the battery. If several Ah-values can be found, use the valueAh (20 h). If several batteries have been combined to a 12 V battery system, add the Ah values. Total capacity for 2 batteries at 110 Ah is 220 Ah. This value -220 Ah- must be set.







After the basic setting, the battery must be charged using a suitable charger (in case of mobile homes using the existing board charger) for a duration of 24 h. This is absolutely required, so that the battery computer is able to recognize 100 % full charging required for starting. If the smart shunt loses its voltage supply (battery disconnected etc.), also proceed as described above.

After adjustment of the battery capacity and after loss of the supply voltage, the residual capacity will be estimated automatically by means of the battery voltage. After that, the battery must imperatively be charged for at least 24 hours with a suitable automatic charger to ensure correct display of the capacity. Only when the battery had been fully charged, the system adjusts itself to "its" battery, and the display will show 100 % or the residual capacity of the battery in Ah. The initial settings and the full charging of the battery are absolutely required to ensure proper capacity indication, and it must be repeated whenever the unit or the battery had been disconnected!

Access to the Menu

Access to the menu is only possible, if the display is switched to board battery, i. e. the LED "Board" must be lighting. Press and hold the key "Battery Computer"  (for approx. 3 seconds), until "Set" will be flashing at the upper edge of the display. Now the menu is active.

Menu - Navigation and Exit

The individual settings can be scrolled consecutively using the key "Battery Computer" . Use the arrow keys   to change the settings. Quick setting of big values is effected by pressing and holding the arrow keys  . When having scrolled through all menu items, the display will change to the normal operating state.

Menu Items

At each menu item, the symbol "Set" will be displayed at the upper edge of the menu.

Set

100

Ah

Nominal Capacity Board Battery (C20)

Set

64P

Set

34

Adjustment Type Board Battery
The value to be set can be drawn from the table of the battery types. If an inadmissible type is set and when changing to the next page, the display jumps to the last admissible value.

The displays are flashing alternately.

Set Off

10.5

V

Board battery disconnection threshold low voltage in V

Set On

101

%

Board battery start threshold in %

Set Off

30

%

Board battery disconnection threshold in %

Set On

6U22

Set Off

6U22

Activation / Deactivation audible alarm device
The audible alarm can be activated or deactivated generally. "On" or "Off" will be displayed correspondingly at the upper menu margin.

The displays are flashing alternately.

Battery Type:

The possible battery types and their number for setting in the menu can be drawn from the table.

Type	Volts U1 approx.	Set Value
Lead-Acid/Lead-Acid	14.4	24
Gel	14.4	53
AGM-14.4	14.4	34
AGM-14.7-14.8	14.7-14.8	47
LiFePo4 13.9 V	13.9	89
LiFePo4 14.2 V	14.2	82
LiFePo4 14.4 V	14.4	84
LiFePo4 14.6 V	14.6	86
LiFePo4 14.8 V	14.8	88

Safety Instructions:



Safety Regulations and Appropriate Application:

The VPC Jupiter 100, VPC Jupiter 200, VPC Jupiter 400 had been designed according to the valid safety regulations.

Appropriate application is restricted to:

- Control of commercial types of lead storage batteries (lead-acid, gel, AGM), as well as LiFePo4, of the indicated nominal voltage and of connected consumers in fixed installed systems.
- With observation of the capacity limits of the smart shunt (see "Technical Data").
- Together with the supplied smart shunt.
- Technically faultless condition.
- Installation in a well-ventilated room, protected from rain, humidity, dust, aggressive battery gases, as well as in an environment being free from condensation water.
- With a rear insulating cover of the display unit.
- Never use the unit in locations where the risk of gas or dust explosion exists!
- Open-air operation of the unit is not allowed.
- Cables are always to be laid in such a way that damage is excluded. Observe to fasten them tightly.
- Never lay 12 V (24 V) cables and 230 V mains supply cables into the same cable conduit (empty conduit).
- Check live cables or leads periodically for insulation faults, points of break or loosened connections. Occurring defects must be remedied immediately.
- The unit is to be disconnected from any connection prior to execution of electrically welding or work on the electric system.
- If the user is not able to draw from the manual, which characteristic values are valid for a unit or which regulations are to be observed, a specialist is to be consulted.
- The user/buyer is obliged to observe any construction and safety regulations.
- Except of the smart shunt, no further connection (such as of consumers) should exist at the negative pole of the battery or at the negative pole of the entire battery system!
- Keep children away from the batteries and the smart shunt.
- Observe the safety regulations of the battery manufacturer.
- The consumer disconnection via the terminal does not replace the BMS (battery management system) or the safety disconnection for lithium iron-phosphate battery systems planned by the battery manufacturer.
- Ventilate the battery room.
- The unit is not equipped with parts, which can be replaced by the user.
- Non-observance may result in injury or material damage.
- Never use solvents or aggressive household cleaners for cleaning of the display!
- The warranty period is 24 months from the purchase date (against presentation of the sales slip or invoice).
- The warranty will be void in case of any inappropriate utilisation of the unit, if it is used beyond the technical specification, in case of improper operation or external intervention. We do not assume any liability for any damage resulting hereof. The liability exclusion is extended to any service being executed by third, which has not been ordered by us in writing. Service is to be effected exclusively by VOTRONIC, D-36341 Lauterbach.

Notes:

Technical Data

System:			
Nominal Voltage Board Battery	12 V		
Operating Voltage Range Board Battery	8...16 V		
Current Draw	13...60 mA, depending on illumination		
Battery Types	See Table "Battery Type"		
Nominal Voltage Starter Battery	12 V / 24 V		
Operating Voltage Range Starter Battery	8...35 V		
Switching Current Terminal Main Switch	max. 0.3 A		
Switching Current Pump	max. 16 A		
USB Charging Socket	5 V / 2.5 A acc. to "USB Battery Charging Specification, Rev 1.1"		
Ambient Conditions, Humidity of Air:	max. 95 % RH, no condensation		
Display Unit (LCD Display):			
Technology	LC Display with specific segments, legible with and without illumination, Membrane keyboard with LED background illumination		
Representation Surface	49 x 28 mm		
Lighting	white LED		
Dimensions	200 x 75 x 30 mm		
Assembly Dimensions Opening Electronic System	approx. 185 x 57 mm		
Weight	approx. 200 g		
Smart Shunt:	100 A	200 A	400 A
Max. Admissible current Smart Shunt:			
Nominal Current	100 A	200 A	400 A
Max. Current 15 Minutes	150 A	300 A	600 A
Max. Current 7 Minutes	200 A	400 A	800 A
Max. Current Short-time	450 A	900 A	1800 A
Weight	240 g	240 g	245 g
Dimensions Smart Shunt	135 x 32 x 44 mm		
Ground Strap:			
Cross-Section	25 mm ²	35 mm ²	75 mm ²
Weight	100g	140 g	360 g

Delivery Scope:

- 1 Pc. VPC Jupiter Display and Control Panel
- 1 Pc. Smart Shunt 100 A, 200 A or 400 A
- 1 Pc. Ground Strap
- 2 Pcs. Control Cable, Length 5 m
- 2 Pcs. Temperature Sensor
- 4 Pcs. Fastening Screws
- 1 Pc. Operating Manual
- 1 Pc. Drilling Jig

Available Accessories:

- | | |
|---|----------------|
| Control Cable Extension, Length 5 m | Order No. 2005 |
| Temperature Sensor 825 | Order No. 2001 |
| Temperature Sensor 625 | Order No. 2088 |
| Switch Unit 40 | Order No. 2071 |
| Switch Unit 100 | Order No. 2072 |
| Battery Protector 300 | Order No. 3084 |
| Different VOTRONIC Tank Measuring Sensors of the Product Category "Mobile Leisure Time" | |



Declaration of Conformity:

In accordance with the provisions of Directives 2014/35/EU, 2014/30/EU, 2009/19/EC, this product complies with the following standards or normative documents:
EN55014-1; EN55022 B; EN61000-6-1; EN61000-4-2; EN61000-4-3; EN61000-4-4; EN62368-1; EN50498.



The product must not be disposed of in the household waste.



The product is RoHS compliant. It complies with the directive 2011/65/EU for Reduction of Hazardous Substances in electrical and electronic equipment.



Subject to misprints, errors and technical modification without notice.

All rights reserved, particularly the right of reproduction. Copyright © VOTRONIC 05/2018.

Made in Germany by

VOTRONIC Elektronik-Systeme GmbH, Johann-Friedrich-Diehm-Str. 10, 36341 Lauterbach/GERMANY

Phone: +49 (0)6641/91173-0 Fax: +49 (0)6641 / 91173-20 E-mail: info@votronic.de Internet: www.votronic.de