



## Pure sine wave inverter

---

# USER MANUAL



IP350-Plus, IP500-Plus  
IP1000-Plus, IP1500-Plus  
IP2000-Plus, IP3000-Plus  
IP4000-Plus, IP5000-Plus



# Contents

<b>Important safety instructions</b>	<b>1</b>
<b>1 Overview</b>	<b>5</b>
<b>2 Appearance</b>	<b>7</b>
<b>3 Naming rule</b>	<b>12</b>
<b>4 Connection diagram</b>	<b>14</b>
<b>5 Remote meter</b>	<b>16</b>
5.1 Appearance	16
5.2 Buttons	16
5.3 LCD interface	17
5.3.1 Real-time interface	17
5.3.2 Parameters setting	17
5.3.3 Power Saving Mode	17
5.3.4 Parameters user define	19
5.4 Error code	20
<b>6 Installation</b>	<b>21</b>
6.1 Attentions	21
6.2 Wire size and circuit breaker	21
6.3 Mounting	24
6.4 Rotate the LCD	29
<b>7 Protections</b>	<b>30</b>
<b>8 Troubleshooting</b>	<b>34</b>
<b>9 Maintenance</b>	<b>35</b>
<b>10 Specifications</b>	<b>36</b>
<b>Appendix 1 Disclaimers</b>	<b>47</b>

# Important safety instructions





## Please reserve this manual for future review.

This manual contains all safety, installation, and operation instructions for the IPower-Plus series high-frequency pure sine wave inverter ("inverter" referred to in this manual).

### 1. Explanation of symbols

Please read related literature accompanying the following symbols to efficiently use the product and ensure personal and property safety.

The entire system should be installed by professional and technical personnel.

Symbol	Definition
<b>TIP</b>	Indicate any practical advice for reference.
	<b>IMPORTANT:</b> Indicates a critical tip during the operation, if ignored, may cause the device to run in error.
	<b>CAUTION:</b> Indicates potential hazards, if not avoided, may cause the device damaged.
	<b>WARNING:</b> Indicates the danger of electric shock, if not avoided, would cause casualties.
	<b>WARNING HOT SURFACE:</b> Indicates the risk of high temperature, if not avoided, would cause scalds.
	Read the user manual carefully before any operation.

 <b>WARNING</b>	The entire system should be installed by professional and technical personnel.
--	--

### 2. Requirements for professional and technical personnel



- Professionally trained;
- Familiar with related safety specifications for the electrical system;
- Read this manual carefully and master related safety cautions.

### 3. Professional and technical personnel is allowed to do

- Install the inverter to a specified location.
- Conduct trial operations for the inverter.

- Operate and maintain the inverter.

#### 4. Safety cautions before installation

 <b>IMPORTANT</b>	<p>When you receive the inverter, check whether there is any damage in transportation. Contact the transportation company, our local distributor, or our company for any problem.</p>
 <b>CAUTION</b>	<ul style="list-style-type: none"> <li>When placing or moving the inverter, follow the instructions in the manual.</li> <li>When installing the inverter, evaluate whether the operation area exists arc danger.</li> <li>The inverter needs to be connected to a battery. The battery's minimum capacity (Ah) is recommended to be five times the current that equals the inverter's rated output power divided by the battery's voltage.</li> </ul>
 <b>WARNING</b>	<ul style="list-style-type: none"> <li>Keep the inverter out of the reach of children.</li> <li>This inverter is an off-grid type. It is strictly prohibited to connect the inverter to the grid. Otherwise, the inverter will be damaged.</li> <li>This inverter is only allowed for stand-alone operation. It is prohibited to connect multiple units in parallel or series. Otherwise, the inverter will be damaged.</li> </ul>

#### 5. Safety cautions for mechanical installation



 <b>WARNING</b>	<ul style="list-style-type: none"> <li>Before installation, ensure the inverter has no electrical connection.</li> <li>Confirm enough heat dissipation space for the inverter before installation. Do not install the inverter in humid, salt spray, corrosion, greasy, flammable, explosive, dust accumulative, or other severe environments.</li> </ul>
---	---

#### 6. Safety cautions for electrical connection

 <b>CAUTION</b>	<ul style="list-style-type: none"> <li>Check whether wiring connections are tight to avoid the danger of heat accumulation due to loose connections.</li> <li>The protective grounding is connected to the ground. The cross-section of the wire should not be less than 4mm<sup>2</sup>.</li> <li>The DC input voltage must strictly follow the parameter table. Too high or too low DC input voltage will affect the inverter's normal operation and damage it.</li> <li>It is recommended that the connection length between the battery and the</li> </ul>
---	--

	<p>inverter be less than 3 meters. If greater than 3 meters, please reduce the current density of the connection wire.</p> <ul style="list-style-type: none"> <li>• A fast-acting fuse or breaker should be used between battery and Inverter; the fast-acting fuse or breaker's rated current should be twice the inverter rated input current.</li> <li>• DO NOT install the inverter close to the flooded lead-acid battery because the terminals' sparkle may ignite the hydrogen released by the battery.</li> </ul>
 <p><b>WARNING</b></p>	<ul style="list-style-type: none"> <li>• The AC output terminal is only for the load connection. Do NOT connect it to another power source or utility. Otherwise, the inverter will be damaged. Turn off the inverter when connecting loads.</li> <li>• It is strictly forbidden to connect a transformer or a load with a surge power (VA) exceeding the overload power at the AC output port. Otherwise, the damage will be caused to the inverter.</li> <li>• Do not connect battery chargers or other similar products to the input terminal of the inverter. Otherwise, the inverter will be damaged.</li> </ul>

#### 7. Safety cautions for controller operation

 <p><b>WARNING</b> <b>HOT</b> <b>SURFACE</b></p>	<p>When the inverter is working, the cover temperature is very high because of the accumulated heat; please do not touch it.</p>
 <p><b>CAUTION</b></p>	<p>When the inverter is running, please do not open the cabinet.</p>
 <p><b>WARNING</b></p>	<p>The inverter's AC output is of high voltage, do not touch the wiring connection to avoid electric shock.</p>

#### 8. Dangerous operations which would cause electric arc, fire or explosion

- Touch the wire end that hasn't been insulation treated and maybe electriferous.
- Touch the wiring copper row, terminals, or internal modules of the inverter that may be electriferous.
- The connection of the power cable is loose.
- Screw or other spare parts inadvertently falls into the inverter.
- Improper operations by untrained non-professional or technical personnel.

**WARNING**

Once an accident occurs, it must be handled by professional and technical personnel. Improper operations would cause more serious accidents.

**9. Safety cautions for stopping the inverter**

- After the inverter stop running for five minutes, the internal conductive modules could be touched.
- The inverter is allowed to restart after removing the faults, which affects safety performance.
- There are no serviceable parts inside. If any maintenance service is required, please contact our service personnel.

**WARNING**

Do NOT touch or open the shell after the inverter is powered off within ten minutes.

**10. Safety cautions for inverter maintenance**

- It is recommended to check the inverter with testing equipment to ensure there is no voltage and current.
- When conducting electrical connection and maintenance, post a temporary warning sign or put up barriers to prevent unrelated personnel from entering the electrical connection or maintenance area.
- An improper operation of the inverter may cause personal injury or equipment damage.
- Please wear an anti-static wrist strap to prevent static damage or avoid unnecessary contact with the circuit board.

# 1 Overview

IPower-Plus is a new generation of pure sine wave inverter compatible with the lithium battery system. This new inverter adopts surge current suppression technology to effectively prevent the surge current from damaging the lithium battery cells and BMS (Battery Management System). Also, adopting the voltage and current double closed-loop control algorithm brings the inverter a faster response and better resistance to the load impact. The inverter selects key components with a high power density and long lifespan to provide a stable and reliable power guarantee. The optional communication solutions allow users to monitor the real-time status or change the parameters wherever.

The inverter can be widely used in DC to AC areas, such as solar AC power system, vehicle system, RV power supply, security monitoring system, emergency lighting system, field power system, household power system, etc. With an excellent EMC (Electro Magnetic Compatibility) characteristic, the inverter is also suitable for occasions with high power quality requirements.

## **Features:**

- Completely electrically isolated design for input and output
- Full digital double closed-loop control
- Excellent EMC characteristic, widely applied to higher quality power system
- Advanced SPWM technology and pure sine wave output.
- Input surge current suppression technology, applying to the lithium battery system
- Outstanding load resistance to impact, applying to the air conditioners, washing machines, refrigerators, etc.
- High power density and high-quality components to ensure the reliability
- Output power factor up to 1
- Low loss of zero loads and standby. Low THD (Total Harmonic Distortion). High conversion efficiency
- Extensive protections: input reverse polarity/under voltage/over voltage, output overload/short circuit/overheating
- Air cooling is controlled by temperature and load
- Rotatable LCD meter to simplify the system wiring<sup>①</sup>
- Friendly LCD meter to simply monitor and parameter configure<sup>①</sup>
- Remote control by the phone Apps and PC software
- Configurable output voltage, output frequency and baud rate<sup>②</sup>
- Enable power saving mode(PSE) conveniently<sup>②</sup>
- Charging mobile phones, DC fans, and other electrical equipment by the USB port<sup>③</sup>



- Support a variety of options by connecting with the RS485 com. port<sup>④</sup>
  - External switch contact design to allow remote control
  - EN/IEC62109, EN61000-6-1/3, RoHS, ETL and FCC approved
- ① **There is no LCD meter for the IP350-Plus series.**
  - ② **Configure the parameters via the local LCD meter (no including the IP350-Plus series), remote LCD meter, phone Apps, or PC software.**
  - ③ **This function is unavailable for inverters with 48V input voltage.**
  - ④ **There is no communication isolation design for inverters with 12V/24 input voltage. This function(communication isolation design) is just for inverters with 48V input voltage.**

## 2 Appearance

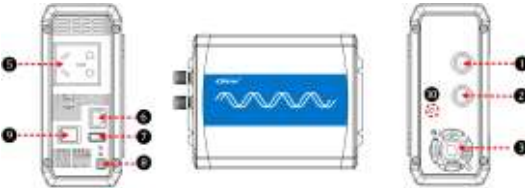
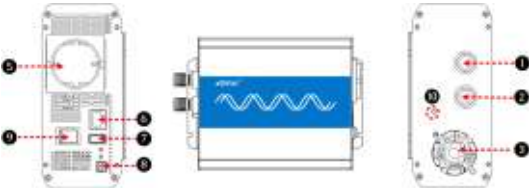
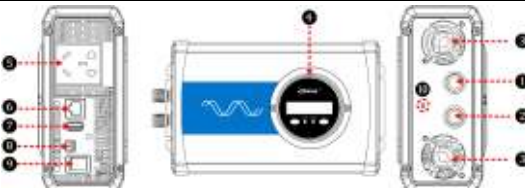
AC Output voltage	100/110/120VAC		220/230/240VAC	
IP350-Plus	AC output port	T, N	AC output port	T, C
	The appearance is the same as "Figure 1."			
	AC output port	A, E, F, UK		
	 <p data-bbox="481 522 554 542">Figure 1</p>		 <p data-bbox="1059 553 1132 573">Figure 2</p>	
IP500-Plus	AC output port	T, N	AC output port	T, C
	The appearance is the same as "Figure 3."			
	AC output port	GFCI		
	 <p data-bbox="481 832 554 853">Figure 3</p>			
			AC output port	
			A, E, F, UK	

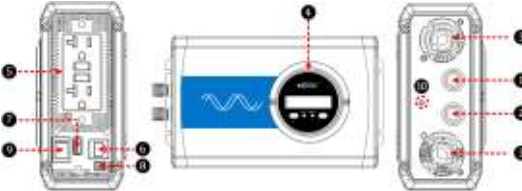
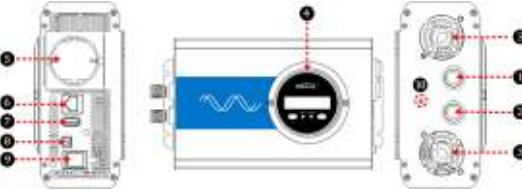
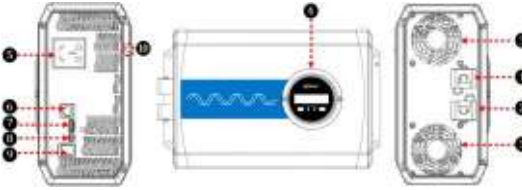
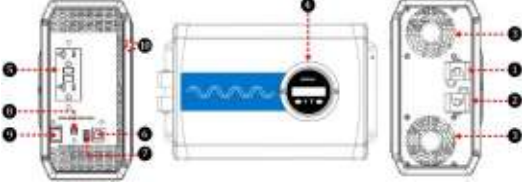
	 <p style="text-align: center;"><b>Figure 4</b></p>	 <p style="text-align: center;"><b>Figure 5</b></p>				
IP1000-Plus  IP1500-Plus	<table border="1" style="width: 100%; border-collapse: collapse;"> <tr> <td style="width: 20%;"><b>AC output port</b></td> <td><b>T, N, TN</b></td> </tr> </table>  <p style="text-align: center;"><b>Figure 6</b></p>	<b>AC output port</b>	<b>T, N, TN</b>	<table border="1" style="width: 100%; border-collapse: collapse;"> <tr> <td style="width: 20%;"><b>AC output port</b></td> <td><b>T, C, TC, TE, TF, A, TA, UK, TUK</b></td> </tr> </table> <p style="text-align: center;">The appearance is the same as "Figure 6."</p>	<b>AC output port</b>	<b>T, C, TC, TE, TF, A, TA, UK, TUK</b>
	<b>AC output port</b>	<b>T, N, TN</b>				
<b>AC output port</b>	<b>T, C, TC, TE, TF, A, TA, UK, TUK</b>					
<table border="1" style="width: 100%; border-collapse: collapse;"> <tr> <td style="width: 20%;"><b>AC output port</b></td> <td><b>GFCI</b></td> </tr> </table>  <p style="text-align: center;"><b>Figure 7</b></p>	<b>AC output port</b>	<b>GFCI</b>	<table border="1" style="width: 100%; border-collapse: collapse;"> <tr> <td style="width: 20%;"><b>AC output port</b></td> <td><b>E, F</b></td> </tr> </table> <p style="text-align: center;">The appearance is the same as "Figure 7."</p>	<b>AC output port</b>	<b>E, F</b>	
<b>AC output port</b>	<b>GFCI</b>					
<b>AC output port</b>	<b>E, F</b>					
IP3000-11-Plus	<table border="1" style="width: 100%; border-collapse: collapse;"> <tr> <td style="width: 20%;"><b>AC output port</b></td> <td><b>T</b></td> </tr> </table>	<b>AC output port</b>	<b>T</b>	<table border="1" style="width: 100%; border-collapse: collapse;"> <tr> <td style="width: 20%;"><b>AC output port</b></td> <td><b>T</b></td> </tr> </table>	<b>AC output port</b>	<b>T</b>
<b>AC output port</b>	<b>T</b>					
<b>AC output port</b>	<b>T</b>					

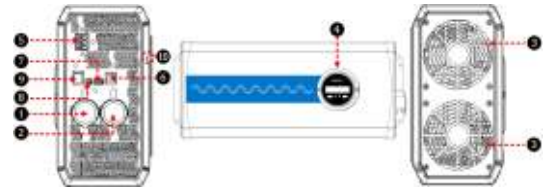
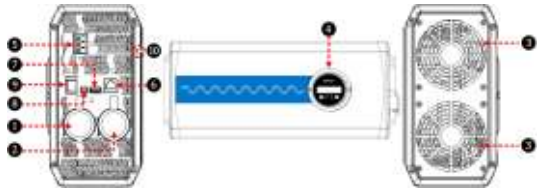
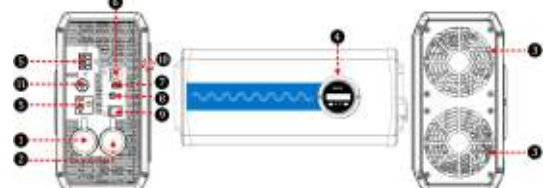
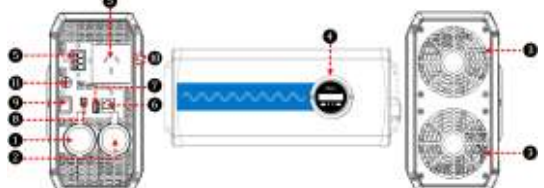
IP3000-12-Plus	 <p>Figure 8</p>		 <p>Figure 9</p>	
	AC output port	TN	AC output port	TC, E, TE, F, TF, TA, TUK
IP3000-21-Plus IP3000-22-Plus IP4000-41-Plus	 <p>Figure 10</p>		 <p>Figure 11</p>	
	AC output port	T	AC output port	T
		<p>The appearance is the same as "Figure 12."</p>		
		<p>Figure 12</p>		

	<table border="1"> <tr> <th data-bbox="235 98 394 129">AC output port</th> <th data-bbox="394 98 802 129">TN</th> </tr> <tr> <td data-bbox="235 129 394 377">  </td> <td data-bbox="394 129 802 377">  </td> </tr> <tr> <td colspan="2" data-bbox="474 356 559 377" style="text-align: center;">Figure 13</td> </tr> </table>	AC output port	TN			Figure 13		<table border="1"> <tr> <th data-bbox="813 98 962 129">AC output port</th> <th data-bbox="962 98 1383 129">TC、E、TE、F、TF、TA、TUK</th> </tr> <tr> <td colspan="2" data-bbox="813 129 1383 377" style="text-align: center;">The appearance is the same as "Figure 13."</td> </tr> </table>	AC output port	TC、E、TE、F、TF、TA、TUK	The appearance is the same as "Figure 13."	
AC output port	TN											
												
Figure 13												
AC output port	TC、E、TE、F、TF、TA、TUK											
The appearance is the same as "Figure 13."												
<p>IP3000-41-Plus</p> <p>IP4000-42-Plus</p>	<table border="1"> <tr> <th data-bbox="235 385 394 416">AC output port</th> <th data-bbox="394 385 802 416">T</th> </tr> <tr> <td data-bbox="235 416 394 656">  </td> <td data-bbox="394 416 802 656">  </td> </tr> <tr> <td colspan="2" data-bbox="474 632 559 653" style="text-align: center;">Figure 14</td> </tr> </table>	AC output port	T			Figure 14		<table border="1"> <tr> <th data-bbox="813 385 962 416">AC output port</th> <th data-bbox="962 385 1383 416">T</th> </tr> <tr> <td colspan="2" data-bbox="813 416 1383 656" style="text-align: center;">The appearance is the same as "Figure 14."</td> </tr> </table>	AC output port	T	The appearance is the same as "Figure 14."	
AC output port	T											
												
Figure 14												
AC output port	T											
The appearance is the same as "Figure 14."												
<p>IP5000-42-Plus</p>	<table border="1"> <tr> <th data-bbox="235 665 394 696">AC output port</th> <th data-bbox="394 665 802 696">TN</th> </tr> <tr> <td data-bbox="235 696 394 902">  </td> <td data-bbox="394 696 802 902">  </td> </tr> <tr> <td colspan="2" data-bbox="821 795 1176 816" style="text-align: center;">The appearance is the same as "Figure 15."</td> </tr> </table>	AC output port	TN			The appearance is the same as "Figure 15."		<table border="1"> <tr> <th data-bbox="813 665 962 696">AC output port</th> <th data-bbox="962 665 1383 696">TC、E、TE、F、TF、TA、TUK</th> </tr> <tr> <td colspan="2" data-bbox="813 696 1383 902" style="text-align: center;">The appearance is the same as "Figure 15."</td> </tr> </table>	AC output port	TC、E、TE、F、TF、TA、TUK	The appearance is the same as "Figure 15."	
AC output port	TN											
												
The appearance is the same as "Figure 15."												
AC output port	TC、E、TE、F、TF、TA、TUK											
The appearance is the same as "Figure 15."												

Figure 15

①	DC input terminal positive <sup>①</sup>	④	LCD	⑦	USB output port 5VDC/Max.1A <sup>②</sup>	⑩	Grounding terminal
②	DC input terminal negative <sup>①</sup>	⑤	AC output port <sup>①</sup>	⑧	External switch port	⑪	Fast-acting fuse terminal <sup>③</sup>
③	Cooling fan	⑥	RS485 communication port	⑨	Inverter switch	--	--

① The DC input terminal and the AC output port varies with different products. Please refer to the real product.

② USB output port is not available for inverters with 48V input voltage.

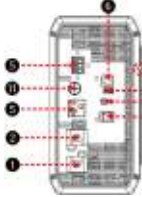
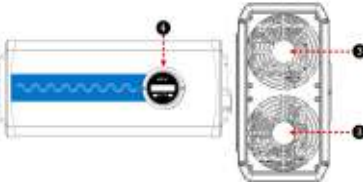
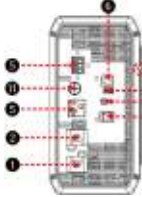
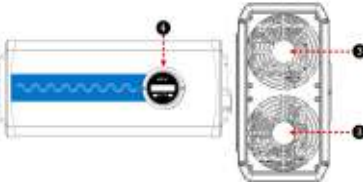
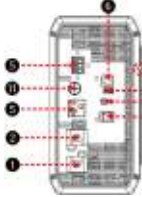
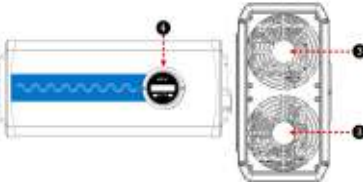
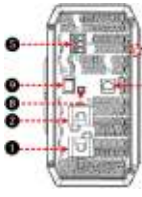
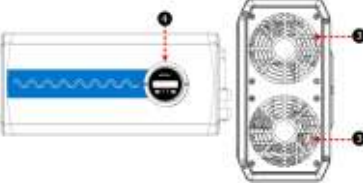
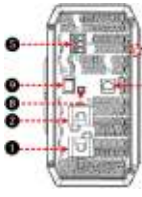
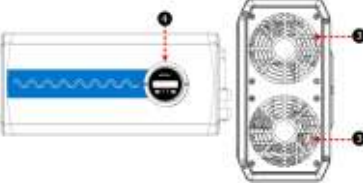
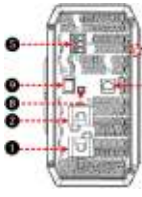
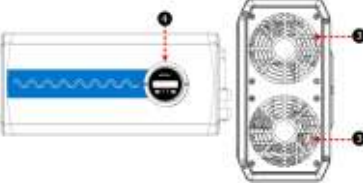
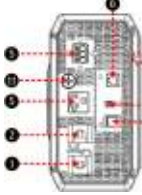
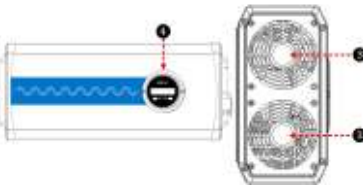
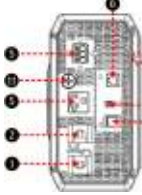
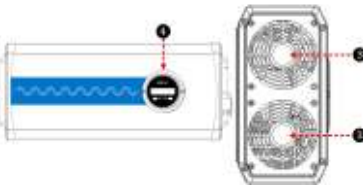
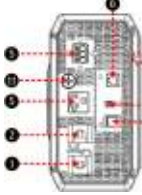
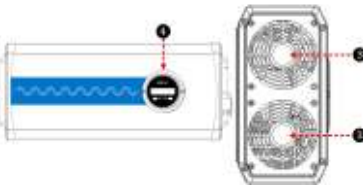
③ The main purpose of the fast-acting fuse terminal ⑪ is to protect the AC socket. The load connected to the product, equipped with a fast-acting fuse terminal, cannot exceed the marked 10A or 20A (Note: Not all the IPower-Plus products are equipped with the fast-acting fuse terminal; the actual products prevail).

➤ Cooling fan







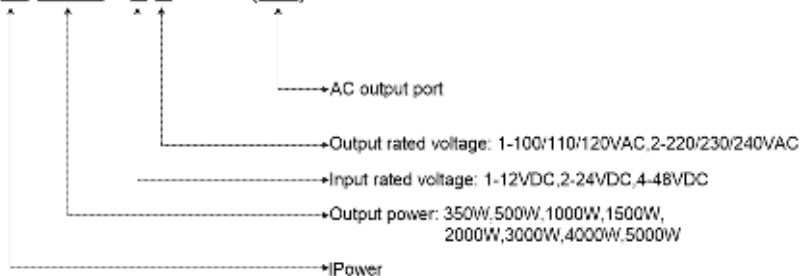





Conditions to start the cooling fan	
Heat sink temperature is higher than 45°C or The internal inverter temperature is higher than 45°C or The output power is higher than 50% of the rated power	All IPower-Plus models
Conditions to stop the cooling fan	
Heat sink temperature is lower than 40°C and The internal inverter temperature is lower than 40°C and The output power is lower than 30% of the rated power	IPower-Plus 500W and below products
Heat sink temperature is lower than 40°C and The internal inverter temperature is lower than 40°C and The output power is lower than 40% of the rated power	IPower-Plus 1000W and above products

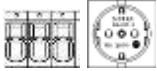

### 3 Naming rule

IP 5000 - 4 2 -Plus(TC)



#### Explanations for the AC output port:

Suffix	Instruction	Figure	Suffix	Instruction	Figure
T	Terminal		GFCI★	American socket (Ground Fault Circuit Interrupt★)	
C	Chinese dual-socket		TC	Terminal + Chinese	
E	European socket		TE	Terminal + European	
A	Australia socket		TA	Terminal + Australia	
UK	United Kingdom socket		TUK	Terminal + United Kingdom	
F	French socket		TF	Terminal + French	
N	American Socket (Applicable to 1500W and		TN	Terminal + American (Applicable to 1500W and below products)	

	below products)			
	American socket (Applicable to 2000W and above products)		Terminal + American (Applicable to 2000W and above products)	

★ GFCI outlets need to be tested after power-on to ensure proper operation.

➤ **Preparation**

Connect a circuit breaker and an AC load (it is recommended to use a night light to observe the status conveniently) to the GFCI outlet. Turn on the inverter after confirming the wiring.

➤ **Testing**

- 1) If the red LED is ON solid, it indicates that the GFCI outlet is damaged; please replace a new one.
- 2) If the LED is green ON after it flashes in red three times, connect the circuit breaker, and the night light will be turned on. Then, press the "TEST" button to observe the testing status:
  - ① The "TEST" button always pops up, and the night light keeps ON solid. It indicates that the GFCI wiring is an error; please correct the wrong wiring.
  - ② The "TEST" button goes down, while the "RESET" button pops up. The LED and the night light are turned off, indicating the GFCI outlet is normal (**Note: Press the "RESET" button again to recover the load output**).

 <b>CAUTION</b>	<b>For detailed product model Vs. AC output port; please refer to the "<i>IPower-Plus Model List</i>".</b>
---	--



## 4 Connection diagram

- IP350-xx-Plus (take the "Appearance with decorative cover" as an example)

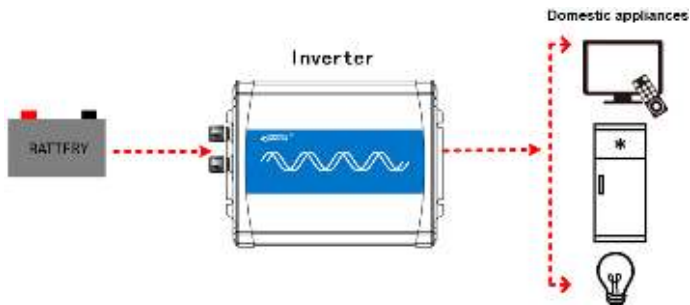

- IP500-xx-Plus (take the "Appearance with decorative cover" as an example)

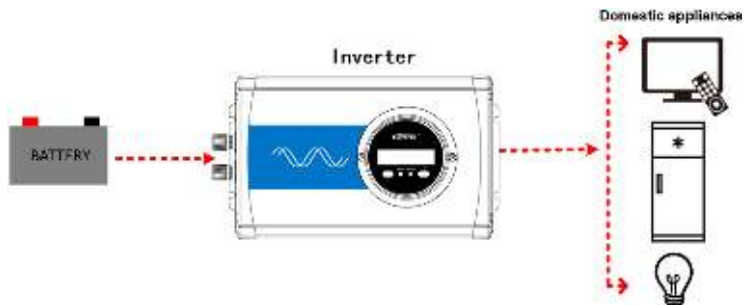

- IP1000-xx/IP1500-xx/IP2000-2x/IP2000-4x/IP3000-42-Plus

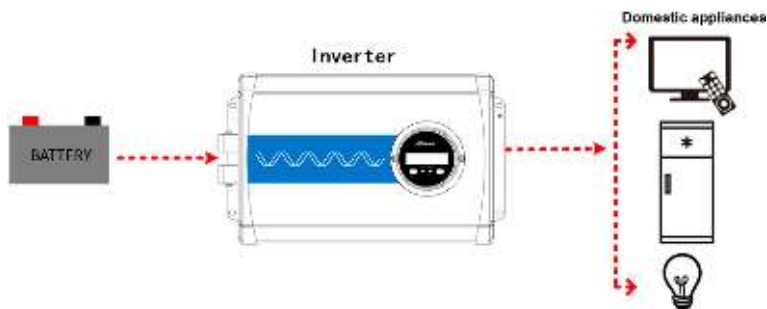

➤ IP2000-1x-Plus

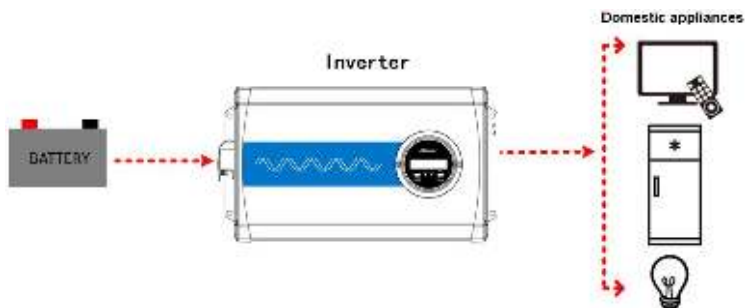

➤ IP3000-1x-Plus

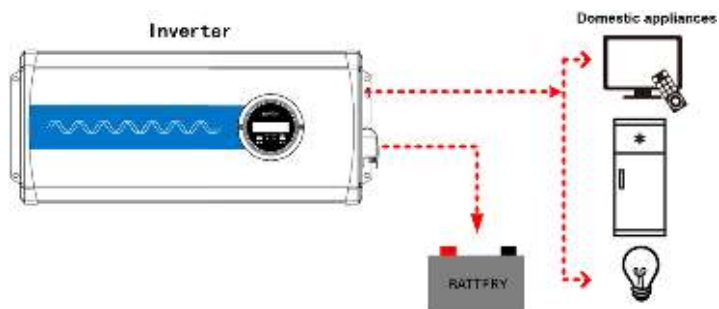

➤ IP3000-2x/IP3000-41/IP4000-4x/IP5000-4x-Plus

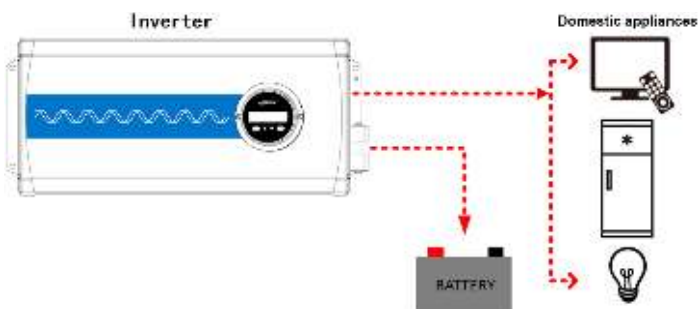

**CAUTION**

It is recommended to connect the inverter DC input terminal to the battery terminal directly. DO NOT connect it to the charge source terminal. Otherwise, the charging voltage spikes of the charge source may cause over-voltage protection of the inverter.

## 5 Remote meter



### 5.1 Appearance



①	LCD★	④	Power indicator(Blue)
②	UP/Setting button	⑤	DOWN/Enter button Output ON/OFF button
③	Fault indicator(red)	⑥	Fixing screws

★ The LCD display can be viewed clearly when the angle between the end-user's horizontal sight and the LCD screen is within 90°. If the angle exceeds 90°, the LCD display cannot be viewed clearly.

### 5.2 Buttons

	Click	Move up/parameter increase
	Press for 2s	In the real-time interface, press it for 2s to enter the setting interface. In the setting interface, press it for 2s to enter the parameters configuration interface.
	Click	Move down/parameter decrease
	Press for 2s	Press it to turn on/off the load output (default ON) in the real-time interface. Confirm the settings
	Click	In the setting interface, click them to exit the parameters configuration interface.
	Press for 2s	In the real-time interface, press them for 2s to clear the faults.





#### CAUTION

The long buzzer beeps for the parameter confirming and short beeps for other button operations.

## 5.3 LCD interface

### 5.3.1 Real-time interface

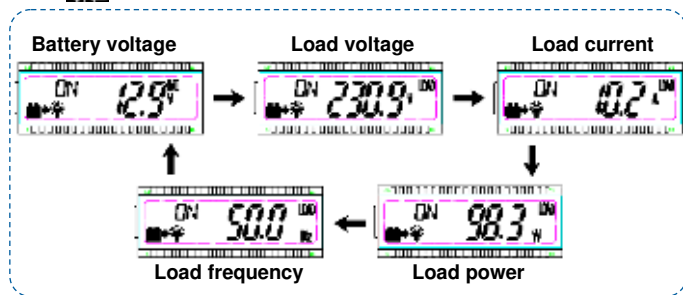

Click  or  to browse the real-time interface.





### 5.3.2 Parameters setting

#### Operation:



**Step1:** In the real-time interface, press  for 2s to enter the parameter setting interface.

**Step2:** Click  or  to select the parameter to be configured.



**Step3:** Press  for 2s to enter the configuration interface of the specified parameter.

**Step4:** Click  or  to configure the parameter value.

**Step5:** Press  for 2s to confirm the configuration.

**Step6:** Click  +  to exit the current interface.

### 5.3.3 Power Saving Mode

Users can enable the power saving mode and set the PSI/PSO value by the  /  button (The

minimum power step is 1VA).

When the actual load power is lower than the PSI (the power to enter the power saving mode), the system will automatically switch to the power saving mode, and then the device output is turned on for 1s and turned off for 5s.

When the actual load power exceeds the PSO (the power to exit the power saving mode), the inverter will automatically exit the power saving mode and resume work.

### 1) Enable power saving mode (PSE)

**Step1:** In the real-time interface of the remote meter, press and hold the  button to enter the parameters setting interface.

**Step2:** Click the  or  button to select the PSE parameter.



**Step3:** Press and hold the  button until the PSE parameter (OFF default) flashes.

**Step4:** Click the  or  button to set the PSE status.



- Select ON to enable the power saving mode.
- Select OFF to disable the power saving mode.





**Step5:** Press and hold the  button to confirm.

### 2) Set the power to exit the power saving mode (PSO)

**Step1:** In the parameters setting interface, click the  or  button to select the PSO parameter.

**Step2:** Press and hold the  button until the PSO value flashes.

**Step3:** Click the  or  button to set the PSO parameter.



- Click the  button to decrease the PSO value by 1.
- Click the  button to increase the PSO value by 1.
- Press and hold the  button to increase the PSO value by 10. After ten adding, the PSO value will increase by 100 each time. When the  button is released, press and hold it again to repeat the above operation (Note: The setting parameter cannot exceeds the user define, or it will back to the initial value to start the loop).





**Step4:** Press and hold the  button to confirm.

### 3) Set the power to enter the power saving mode (PSI)

**Step1:** In the parameters setting interface, click the  or  button to select the PSI parameter.









**Step2:** Press and hold the  button until the PSI value flashes.



**Step3:** Click the  or  button to set the PSI parameter.

- Click the  button to decrease the PSI value by 1.
- Click the  button to increase the PSI value by 1.
- Press and hold the  button to increase the PSI value by 10. After ten adding, the PSI value will increase by 100 each time. When the  button is released, press and hold it again to repeat the above operation (Note: The setting parameter cannot exceeds the user define, or it will back to the initial value to start the loop).

**Step4:** Press and hold the  button to confirm.





### 5.3.4 Parameters user define

Display	Parameters	Default	User define
 VPT	Output voltage class <sup>①</sup>	220VAC	220VAC/230VAC/240VAC
		110VAC	100VAC/110VAC/120VAC
 FRE	Output frequency class <sup>①</sup>	220/230/240VAC: 50Hz 100/110/120VAC: 60Hz	50Hz/60Hz
 BLT	LCD backlight time	30s	30s/ 60s/100s(ON solid)
 PSE	Power Saving Enable	OFF	ON/OFF
 PSI	Power Saving In	20VA	20VA ~ (20%*rated power)
 PSO	Power Saving Out	40VA	(20VA + PSI) ~ (50%*rated power)
 BRS	Baud Rate Select <sup>②</sup>	115200	9600/115200
 LVD	Low voltage disconnect voltage <sup>③</sup>	12V: 10.8V 24V: 21.6V 48V: 43.2V	12V: 10.5V~14.2V; step size 0.1V 24V: 21V-30.2V; step size 0.1V 48V: 42V-62.4V; step size 0.1V

 LVR	Low voltage reconnect voltage <sup>③</sup>	12V: 12.5V 24V: 25V 48V: 50V	12V: 11.5V~15.2V; step size 0.1V 24V: 22V-31.2V; step size 0.1V 48V: 43V-63.4V; step size 0.1V
 OVR	Over voltage reconnect voltage <sup>③</sup>	12V: 14.5V 24V: 29V 48V: 58V	12V: 11.5V~15.2V; step size 0.1V 24V: 22V-31.2V; step size 0.1V 48V: 43V-63.4V; step size 0.1V
 OVD	Over voltage disconnect voltage <sup>③</sup>	12V: 16V 24V: 32V 48V: 64V	12V: 12.5V~16.2V; step size 0.1V 24V: 23V-32.2V; step size 0.1V 48V: 44V-64.4V; step size 0.1V

- ① After configuring the parameters marked with ①, the inverter will restart automatically. It will resume work according to the new parameter value.
- ② Due to the length limit of the LCD displayed data, when the baud rate is set to 115200, the value displayed on the LCD is 1152.
- ③ For the parameter user defines, please refer to the input voltage rules in chapter 7 [Protections](#). Otherwise, the parameter setting will not succeed.

## 5.4 Error code

Error code	Faults	Buzzer	Power indicator	Fault indicator
 ΔOTP	Inverter over temperature Heat sink over temperature	Buzzer beeps	OFF	ON solid
 ΔIOV	Input over voltage	Buzzer beeps	Fast flashing (1Hz)	OFF
 ΔILV	Input low voltage	Buzzer beeps	Slowly flashing (1/4Hz)	OFF
 ΔOSC	Output short circuit	Buzzer beeps	OFF	Fast flashing (1Hz)
 ΔOOL	Output overload	Buzzer beeps	ON solid	Slowly flashing (1/4Hz)

# 6 Installation

## 6.1 Attentions

- Read all the installation instructions carefully in the manual before installation.
- Be very careful when installing the batteries. When installing the open-type lead-acid battery, please wear eye protection and rinse with clean water in time for battery acid contact.
- Keep the battery away from any metal objects, which may cause a short circuit of the battery.
- Loose power connections and corroded wires may result in high heat that can melt wire insulation, burn surrounding materials, or even cause a fire. Ensure tight connections and secure cables with clamps to prevent them from swaying while moving the inverter.
- The DC input voltage must strictly be following the parameter table. Too high or too low DC input voltage will affect the inverter's normal operation and damage it. The surge voltage shall be less than 20V@12V system, less than 40V@24V system, and less than 80V@48V.
- Select the connection cables according to the current density of 3.5A/mm<sup>2</sup> or less.
- Avoid direct sunlight and rain infiltration when installing it outdoor.
- After turn off the power switch, do not open or touch the internal component immediately. Related operations are performed after 10 minutes.
- Do not install the inverter in humid, salt spray, corrosion, greasy, flammable, explosive, dust accumulative, or other severe environments.
- The AC output is of high voltage, do not touch the wiring connection to avoid electric shock.
- To prevent injury, do not touch the fan while it is working.

## 6.2 Wire size and circuit breaker

The wiring and installation methods must conform to the national and local electrical code requirements.

### ➤ Wire, terminals, and circuit breaker selection for battery

Model	Battery wire size	Ring terminal	Circuit breaker
IP350-11-Plus	6mm <sup>2</sup> /10AWG	RNB5.5-6	DC/2P-40A
IP350-12-Plus	6mm <sup>2</sup> /10AWG	RNB5.5-6	DC/2P-40A
IP350-21-Plus	2.5mm <sup>2</sup> /13AWG	RNB3.5-6	DC/2P-32A
IP350-22-Plus	2.5mm <sup>2</sup> /13AWG	RNB3.5-6	DC/2P-32A
IP500-11-Plus	10mm <sup>2</sup> /7AWG	RNB8-6S	DC/2P—63A
IP500-12-Plus	10mm <sup>2</sup> /7AWG	RNB8-6S	DC/2P—63A
IP500-21-Plus	6mm <sup>2</sup> /10AWG	RNB5.5-6	DC/2P-32A
IP500-22-Plus	6mm <sup>2</sup> /10AWG	RNB5.5-6	DC/2P-32A



IP1000-11-Plus	25mm <sup>2</sup> /3AWG	RNB38-6	DC/2P-125A
IP1000-12-Plus	25mm <sup>2</sup> /3AWG	RNB38-6	DC/2P-125A
IP1000-21-Plus	16mm <sup>2</sup> /5AWG	RNB14-6S	DC/2P-63A
IP1000-22-Plus	16mm <sup>2</sup> /5AWG	RNB14-6S	DC/2P-63A
IP1000-41-Plus	6mm <sup>2</sup> /10AWG	RNB5.5-6	DC/2P-40A
IP1000-42-Plus	6mm <sup>2</sup> /10AWG	RNB5.5-6	DC/2P-40A
IP1500-11-Plus ★	25mm <sup>2</sup> /3AWG	RNB60-6	DC-100A(2P in parallel)
IP1500-12-Plus ★	25mm <sup>2</sup> /3AWG	RNB60-6	DC-100A(2P in parallel)
IP1500-21-Plus	16mm <sup>2</sup> /5AWG	RNB14-6S	DC/2P-125A
IP1500-22-Plus	16mm <sup>2</sup> /5AWG	RNB14-6S	DC/2P-125A
IP1500-41-Plus	10mm <sup>2</sup> /7AWG	RNB14-6S	DC/2P-63A
IP1500-42-Plus	10mm <sup>2</sup> /7AWG	RNB14-6S	DC/2P-63A
IP2000-11-Plus ★	35mm <sup>2</sup> /2AWG	RNB70-10	DC-125A(2P in parallel)
IP2000-12-Plus ★	35mm <sup>2</sup> /2AWG	RNB70-10	DC-125A(2P in parallel)
IP2000-21-Plus	35mm <sup>2</sup> /2AWG	RNB38-6	DC/2P-125A
IP2000-22-Plus	35mm <sup>2</sup> /2AWG	RNB38-6	DC/2P-125A
IP2000-41-Plus	16mm <sup>2</sup> /5AWG	RNB14-6S	DC/2P-63A
IP2000-42-Plus	16mm <sup>2</sup> /5AWG	RNB14-6S	DC/2P-63A
IP3000-11-Plus ★	25mm <sup>2</sup> /3AWG	RNB80-10	DC-125A(3P in parallel)
IP3000-12-Plus ★	25mm <sup>2</sup> /3AWG	RNB80-10	DC-125A(3P in parallel)
IP3000-21-Plus ★	25mm <sup>2</sup> /3AWG	RNB60-6	DC-100A(2P in parallel)
IP3000-22-Plus ★	25mm <sup>2</sup> /3AWG	RNB60-6	DC-100A(2P in parallel)
IP3000-41-Plus	25mm <sup>2</sup> /3AWG	RNB22-6S	DC/2P-125A
IP3000-42-Plus	25mm <sup>2</sup> /3AWG	RNB22-6S	DC/2P-125A
IP4000-41-Plus	35mm <sup>2</sup> /2AWG	RNB38-6	DC/2P-125A
IP4000-42-Plus	35mm <sup>2</sup> /2AWG	RNB38-6	DC/2P-125A
IP5000-42-Plus ★	25mm <sup>2</sup> /3AWG	RNB60-6	DC-100A(2P in parallel)

★ According to the recommended battery wire size, **2** pcs battery wires, connected in parallel, are necessary for IP1500-11-Plus, IP1500-12-Plus, IP2000-11-Plus, IP2000-12-Plus, IP3000-21-Plus, IP3000-22-Plus, and IP5000-42-Plus. For connection method, refer to the right figure.

**4** battery wires, connected in parallel, are necessary for IP3000-11-Plus and IP3000-12-Plus.



**IMPORTANT**

The above wire size and circuit breaker size are for reference only; please choose a suitable wire and circuit breaker according to the actual situation.

**➤ Wire and circuit breaker selection for AC output**

Model	Wire size	Circuit breaker
IP350-11-Plus	1mm <sup>2</sup> /18AWG	AC/2P—6A
IP350-12-Plus	1mm <sup>2</sup> /18AWG	AC/2P—6A
IP350-21-Plus	1mm <sup>2</sup> /18AWG	AC/2P—6A
IP350-22-Plus	1mm <sup>2</sup> /18AWG	AC/2P—6A
IP500-11-Plus	1mm <sup>2</sup> /18AWG	AC/2P—10A
IP500-12-Plus	1mm <sup>2</sup> /18AWG	AC/2P—6A
IP500-21-Plus	1mm <sup>2</sup> /18AWG	AC/2P—10A
IP500-22-Plus	1mm <sup>2</sup> /18AWG	AC/2P—6A
IP1000-11-Plus	2.5mm <sup>2</sup> /13AWG	AC/2P-16A
IP1000-12-Plus	1.5mm <sup>2</sup> /15AWG	AC/2P-10A
IP1000-21-Plus	2.5mm <sup>2</sup> /13AWG	AC/2P-16A
IP1000-22-Plus	1.5mm <sup>2</sup> /15AWG	AC/2P-10A
IP1000-41-Plus	2.5mm <sup>2</sup> /13AWG	AC/2P—16A
IP1000-42-Plus	1.5mm <sup>2</sup> /15AWG	AC/2P—10A
IP1500-11-Plus	4mm <sup>2</sup> /11AWG	AC/2P-25A
IP1500-12-Plus	1.5mm <sup>2</sup> /15AWG	AC/2P-10A
IP1500-21-Plus	4mm <sup>2</sup> /11AWG	AC/2P-25A
IP1500-22-Plus	1.5mm <sup>2</sup> /15AWG	AC/2P-10A
IP1500-41-Plus	4mm <sup>2</sup> /11AWG	AC/2P-25A
IP1500-42-Plus	1.5mm <sup>2</sup> /15AWG	AC/2P-10A
IP2000-11-Plus	4mm <sup>2</sup> /11AWG	AC/2P-32A
IP2000-12-Plus	2.5mm <sup>2</sup> /13AWG	AC/2P-16A
IP2000-21-Plus	4mm <sup>2</sup> /11AWG	AC/2P-32A
IP2000-22-Plus	2.5mm <sup>2</sup> /13AWG	AC/2P-16A
IP2000-41-Plus	4mm <sup>2</sup> /11AWG	AC/2P-32A
IP2000-42-Plus	2.5mm <sup>2</sup> /13AWG	AC/2P-16A
IP3000-11-Plus	6mm <sup>2</sup> /10AWG	AC/2P-50A
IP3000-12-Plus	4mm <sup>2</sup> /11AWG	AC/2P-25A
IP3000-21-Plus	6mm <sup>2</sup> /10AWG	AC/2P-50A
IP3000-22-Plus	4mm <sup>2</sup> /11AWG	AC/2P-25A
IP3000-41-Plus	6mm <sup>2</sup> /10AWG	AC/2P-50A

IP3000-42-Plus	4mm <sup>2</sup> /11AWG	AC/2P-25A
IP4000-41-Plus	6mm <sup>2</sup> /10AWG	AC/2P-63A
IP4000-42-Plus	4mm <sup>2</sup> /11AWG	AC/2P-32A
IP5000-42-Plus	4mm <sup>2</sup> /11AWG	AC/2P-40A

 <b>IMPORTANT</b>	<ul style="list-style-type: none"> <li>The above wire size and circuit breaker size are for reference only; please choose a suitable wire and circuit breaker according to the actual situation.</li> <li>The wire size is only for reference. Suppose there is a long distance between the inverter and the battery. In that case, larger wires shall be used to reduce the voltage drop and improve system performance.</li> </ul>
---	--

## 6.3 Mounting

### Installation procedures:

**Step 1: Professional personnel reads this manual carefully.**

**Step 2: Determine the installation location and heat-dissipation space**

To ensure natural thermal convection, you should install the inverter in a place with sufficient airflow and a minimum clearance of 150mm from the inverter's upper and lower edges.

 <b>CAUTION</b>	<p>It is not recommended to install the product in an enclosed cabinet, where the device cooling will be influenced. If mounted in an enclosure cabinet, ensure effective ventilation and not turn on all loads. Or else the device over temperature protection is caused.</p>
---	--

➤ IP350-xx-Plus (take the "Appearance with decorative cover" as an example)

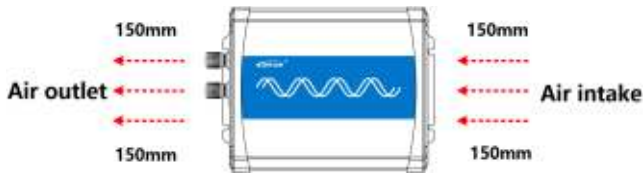

➤ IP500-xx-Plus (take the "Appearance with decorative cover" as an example)



➤ IP1000-xx/IP1500-xx/IP2000-2x/IP2000-4x/IP3000-42-Plus



➤ IP2000-1x-Plus



➤ IP3000-1x-Plus



➤ IP3000-2x/IP3000-41/IP4000-4x/IP5000-4x-Plus



Step3: Wiring



**CAUTION**

- Turn off the inverter switch before wiring.
- Please do not connect the circuit breaker or fast-acting fuse during the wiring and ensure that the poles' leads are connected correctly.
- The terminals and ports on the side vary from the product models.

Wiring sequence (The following wiring sequence is illustrated in the appearance "IP2000-2x-Plus", wiring positions of other inverters. Please refer to chapter [2 Appearance](#) for reference.)

1. Ground connection

The wire size for the ground connection must be thicker or equal to that for the AC output. Refer to

chapter [6.2 Wire size and circuit breaker](#) for detailed wire size.

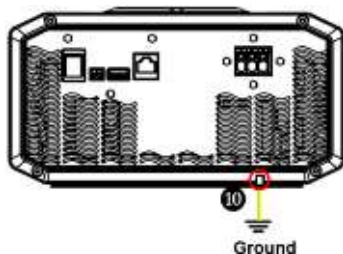

## 2. Battery connection



### CAUTION

A fast-acting fuse must be installed on the battery side, conformed to the following requirements.

1. Fast-acting fuse voltage is 1.5 to 2 times the inverter's rated voltage.
2. Fast-acting fuse current is 2 to 2.5 times the inverter rated current.
3. Distance between the fast-acting fuse and the battery cannot be farther than 150mm.

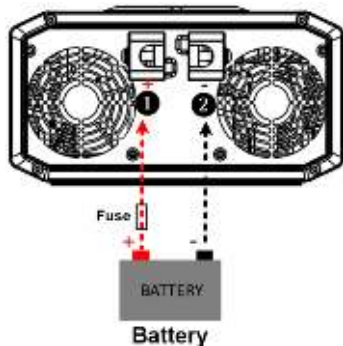

## 3. AC loads connection



### WARNING

- The AC loads shall be determined by the continuous output power of the inverter. The surge power of the AC load must be lower than the instantaneous surge power of the inverter, or the inverter will be damaged.
- The N pole of the AC output port cannot be grounded. If grounding the N pole is necessary, please purchase the IPower-Plus-B series.

### 1) Definition of the AC output port

It varies with different product models; please refer to the actual product. The following takes the AC terminal as an example.



- + It is recommended to use a multi-stranded wire with a wire diameter of not more than 6mm<sup>2</sup>.
- + Add solder to the connection point when selecting the multi-stranded wire and directly insert it into the corresponding port.



- + Stop the inverter before removing the wiring. Then, insert a sharp tool into the small hole (on the top of the port) and pull out the wiring forcefully.

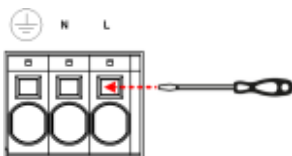

## 2) Connect the AC load

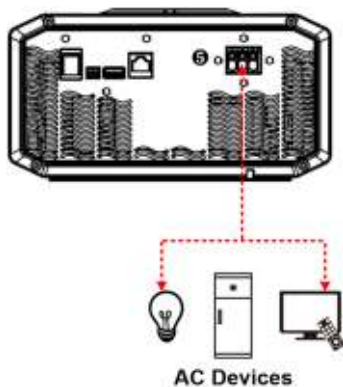

## 4. Optional accessories connection

### 1) RS485 communication port



### RJ45 Pin Definition:

Pin	Definition	Instruction	Pin	Definition	Instruction
1	+5VDC	5V/200mA	5	RS485-A	RS485-A
2	+5VDC		6	RS485-A	
3	RS485-B	RS485-B	7	GND	Power GND
4	RS485-B		8	GND	

### 2) Connect optional accessories

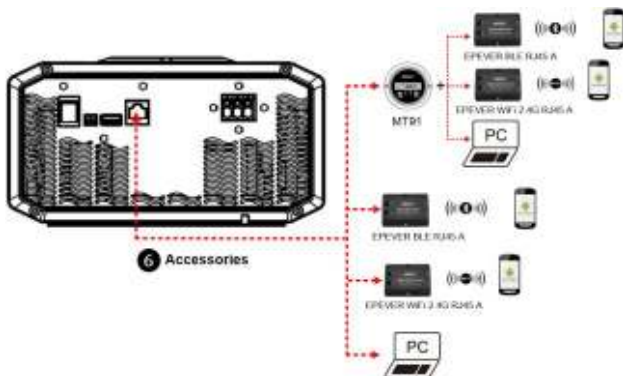

### 5. USB port connection (USB port is not available for inverters with 48V input voltage.)

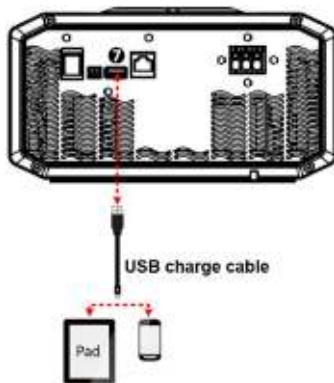

### Step 4: Power on the inverter

- (1) Connect the breaker at the inverter input terminal or the fast-acting fuse at the battery end.

- (2) Turn on the inverter switch; the power indicator will be lighted on, indicating a normal AC output.
- (3) Turn on the AC loads one by one and check the inverter's running status and the loads.



**CAUTION**

When supplying power for different loads, turning on the load with a large impulse current is recommended. And then turn on the load with a smaller impulse current after the load output is stable.

- (4) If the fault indicator flashes red and the buzzer alarms after powering the inverter, please immediately turn off the load and the inverter. Clear the faults according to chapter [8](#) [Troubleshooting](#).

## 6.4 Rotate the LCD

- (1) Remove the screws of the LCD unit with a screwdriver, and rotate it 180°.

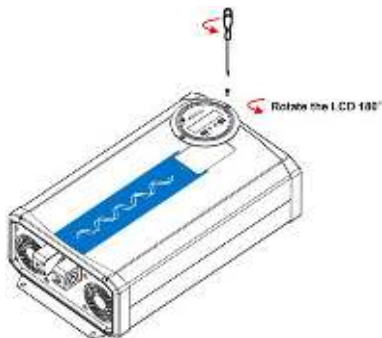

- (2) Secure the screws of the LCD unit to the inverter.

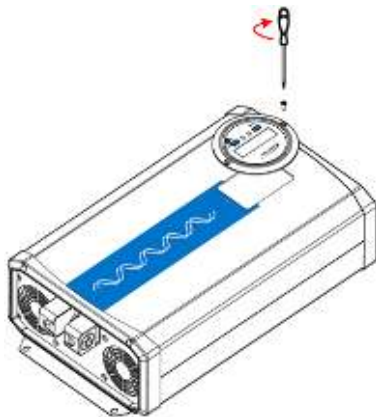





## 7 Protections

### 1) Input reverse polarity protection

When the DC input terminal's polarity is reversed, the indicator will not light up after power on. The buzzer will not sound, and the inverter will not work. The inverter will start to work normally after correcting the error wiring.

### 2) Input voltage protection

- **The following rules must be followed when modifying the battery's input voltage parameters:**
  - A. Over voltage limiting voltage (16.2/32.2/64.4V)  $\geq$  Over voltage disconnect voltage  $\geq$  Over voltage reconnect voltage +1V.
  - B. Over voltage reconnect voltage  $\geq$  Low voltage reconnect voltage.
  - C. Low voltage reconnect voltage  $\geq$  Low voltage disconnect voltage +1V.
  - D. Low voltage disconnect voltage  $\geq$  Low voltage limiting voltage (10.5/21/42V).
- **Detail status is shown as the following when the input voltage protection occurs.**





Input voltage protection	Status
Over voltage protection	The output is switched OFF. The blue indicator fast flashes. Buzzer beeps. LCD displays the 
Over voltage reconnect	The blue indicator is ON solid. The output voltage is normal.
Low voltage protection	The output is switched OFF. The blue indicator slowly flashes. Buzzer beeps. LCD displays the 
Low voltage reconnect	The blue indicator is ON solid. The output voltage is normal.



#### IMPORTANT

The inverter has over voltage protection. Still, the surge voltage shall be less than 20V@12V system, less than 40V@24V system, and less than 80V@48V. Otherwise, the inverter may be damaged.

### 3) Overload protection







IP350-11-Plus IP350-12-Plus IP350-21-Plus IP350-22-Plus IP500-11-Plus IP500-12-Plus IP500-21-Plus IP500-22-Plus	$S=1.2P_e$ (S: Output power; $P_e$ : Rated power)	The output is switched OFF after 1 minute. Buzzer beeps. The red indicator slowly flashes. LCD displays the 
IP1000-11-Plus IP1000-12-Plus IP1000-21-Plus IP1000-22-Plus IP1000-41-Plus IP1000-42-Plus	$S=1.5P_e$ (S: Output power; $P_e$ : Rated power)	The output is switched OFF after 30 seconds. Buzzer beeps. The red indicator slowly flashes. LCD displays the 
IP1500-11-Plus IP1500-12-Plus IP1500-21-Plus IP1500-22-Plus IP1500-41-Plus IP1500-42-Plus	$S=1.8P_e$ (S: Output power; $P_e$ : Rated power)	The output is switched OFF after 10 seconds. Buzzer beeps. The red indicator slowly flashes. LCD displays the 
IP2000-11-Plus ★ IP2000-12-Plus IP2000-21-Plus IP2000-22-Plus IP2000-41-Plus IP2000-42-Plus IP3000-21-Plus ★ IP3000-22-Plus ★ IP3000-41-Plus IP3000-42-Plus	$S > 2P_e$ (S: Output power; $P_e$ : Rated power)	The output is switched OFF after 5 seconds. Buzzer beeps. The red indicator slowly flashes. LCD displays the 



#### CAUTION

When the overload protection happens, the AC output is recovered automatically three times (recover after 5s, 10s, 15s separately). After the recovery attempt failed three times, you need to restart the inverter to recover the AC output.

- ★ When the overload protection happens on IP2000-11-Plus, IP3000-21-Plus or IP3000-22-Plus, the AC output is shut down directly and cannot be recovered automatically.

IP3000-11-Plus	$S=1.5P_e$ (S: Output power; $P_e$ : Rated power)	The output is switched OFF after 10 seconds. Buzzer beeps. The red indicator slowly flashes. LCD displays the  .
	$S \geq 1.6P_e$ (S: Output power; $P_e$ : Rated power)	The output is switched OFF after 5 seconds. Buzzer beeps. The red indicator slowly flashes. LCD displays the  .
IP3000-12-Plus IP4000-41-Plus IP4000-42-Plus	$S=1.5P_e$ (S: Output power; $P_e$ : Rated power)	The output is switched OFF after 10 seconds. Buzzer beeps. The red indicator slowly flashes. LCD displays the  .
	$S \geq 1.7P_e$ (S: Output power; $P_e$ : Rated power)	The output is switched OFF after 5 seconds. Buzzer beeps. The red indicator slowly flashes. LCD displays the  .
IP5000-42-Plus	$S=1.2P_e$ (S: Output power; $P_e$ : Rated power)	The output is switched OFF after 1 minute. Buzzer beeps. The red indicator slowly flashes. LCD displays the  .
	$S=1.4P_e$ (S: Output power; $P_e$ : Rated power)	The output is switched OFF after 10 seconds. Buzzer beeps. The red indicator slowly flashes. LCD displays the  .
	$S > 1.4P_e$ (S: Output power; $P_e$ : Rated power)	The output is switched OFF after 5 seconds. Buzzer beeps. The red indicator slowly flashes. LCD displays the  .

**CAUTION**

When the overload protection happens, the AC output cannot recover automatically. The AC output is shut down according to the multiple of the overload. Recover the AC output after clearing the overload faults and restarting the inverter.

**4) Output short circuit protection**

<b>Faults</b>	<b>Instruction</b>
The output is switched OFF immediately. Buzzer beeps. Red indicators fast flashes. LCD displays the 	Note: The AC output is recovered automatically three times (recover after 5s, 10s, 15s separately). After the recovery attempt failed three times, you need to restart the inverter to recover the AC output.

**5) Inverter over temperature protection**

<b>Faults</b>	<b>Instruction</b>
LCD displays the  The inverter stops working.	The inverter stops working after the heat sink's temperature, or the internal modules' temperature exceeds a set value.
The inverter resumes work.	The inverter works after the temperature of the heat sink or the internal modules' temperature is lower than a set value.

## 8 Troubleshooting

 <b>WARNING</b>	<p>A high voltage will occur inside the inverter. DO NOT try to repair or maintain the inverter by yourself; it may cause an electric shock.</p>
---	--

LCD	Faults	Reasons	Troubleshooting
△ILV	Blue indicator slowly flashes. Buzzer beeps.	The DC input voltage is too low.	Check whether the DC input voltage is lower than 10.8/21.6/43.2V by a multimeter. The inverter will resume work after adjusting the input voltage.
△IOV	Blue indicator fast flashes. Buzzer beeps.	The DC input voltage is too high.	Check whether the DC input voltage is higher than 16/32/64V by a multimeter. The inverter will resume work after adjusting the input voltage.
△OOL	Red indicator slowly flashes. Buzzer beeps.	Overload	Reduce the number of AC loads, and restart the inverter.
△OSC	Red indicators fast flashes. Buzzer beeps.	Output short circuit	Check the loads' connection carefully. Clear the short circuit faults and restart the inverter.
△OTP	Red indicators are ON solid. Buzzer beeps.	Inverter over temperature	Improve the ventilation situation and cool the surroundings' temperature to restart the inverter after the temperature drops. If the fault cannot be cleared after performing the above operations, decline the rated power for usage.

## 9 Maintenance

The following inspections and maintenance tasks are recommended at least two times per year for good performance.

- Make sure no block on airflow around the inverter. Clear up any dirt and fragments on the heat sink.
- Check all the naked wires to ensure insulation is not damaged by sun exposure, frictional wear, dryness, insects or rats, etc.
- Verify the indicator display is consistent with the actual operation.
- Confirm that terminals have no corrosion, insulation damage, high temperature, burnt/discolored sign, and tighten terminal screws to the suggested torque.
- Clear up dirt, nesting insects, and corrosion in time.
- Check and confirm that the lightning arrester is in good condition. Replace a new one in time to avoid damaging the inverter and other equipment.



**WARNING**

Risk of electric shock! Confirm all the power is turned off and all the capacitor's energy has been discharged before performing the above operations.

# 10 Specifications

## 100/110/120VAC output

Parameters	IP350-11-Plus	IP350-21-Plus	IP500-11-Plus	IP500-21-Plus
Continuous output power	350W@35°C@ Rated input voltage		500W@35°C@35°C@ Rated input voltage	
Surge power	700W@5S		1000W@5S	
Surge current when power on	< 30A		< 50A	
Output voltage	100VAC/110VAC (±3%); 120VAC (-7%~+3%)			
Output frequency	50/60Hz ± 0.2%			
Output wave	Pure Sine Wave			
Output distortion THD	THD ≤ 4% (Resistive load)	THD ≤ 3% (Resistive load)	THD ≤ 4% (Resistive load)	
Load power factor	0.2 ~ 1 (Load power ≤ Continuous output power)			
Rated input voltage	12VDC	24VDC	12VDC	24VDC
Input voltage range	10.8 ~ 16.0VDC	21.6 ~ 32VDC	10.8 ~ 16.0VDC	21.6 ~ 32VDC
Rated output efficiency <sup>①</sup>	> 87.0%	> 90.0%	> 87.5%	> 90.0%
Max. output efficiency <sup>②</sup>	> 89.0% (70% loads)	> 90.5% (70% loads)	> 90.0% (40% loads)	> 91.0% (40% loads)
Idle current	< 0.15A	< 0.10A	< 0.15A	< 0.10A
No-load current	< 0.8A	< 0.4A	< 0.8A	< 0.5A
USB output	5VDC/Max.1A			
RS485 com. port	5VDC/200mA			
Mechanical parameters				
Input terminal	M6		M6	
Dimension (L x W x H)	229 x 163.5 x 75mm (with decorative cover) 229 x 160 x 73mm (without decorative cover)		286 x 163.5 x 78mm (with decorative cover) 286 x 160 x 78mm (without decorative cover)	

Mounting size (L x W)	205 x 75mm	262 x 75mm
Mounting hole size	Φ5mm	Φ5mm
Net Weight	1.5Kg	2.3kg

① It is measured in the condition of continuous output power and rated input voltage.

② It means the max. output efficiency when the inverter is connected with different loads under the rated input voltage.

Parameters	IP1000-11-Plus	IP1000-21-Plus	IP1000-41-Plus
Continuous output power	1000W@35°C@ Rated input voltage		
Surge power	2000W@5S		
Surge current when power on	< 100A		< 35A
Output voltage	100VAC/110VAC (±3%); 120VAC (-7%~+3%)		100VAC/110VAC/120VAC (±3%)
Output frequency	50/60Hz ± 0.2%		
Output wave	Pure Sine Wave		
Output distortion THD	THD ≤ 4% (Resistive load)	THD ≤ 3% (Resistive load)	THD ≤ 3% (Resistive load)
Load power factor	0.2~1(Load power ≤ Continuous output power)		
Rated input voltage	12VDC	24VDC	48VDC
Input voltage range	10.8~16.0VDC	21.6~32.0VDC	43.2 ~ 64.0VDC
Rated output efficiency <sup>①</sup>	> 87.0%	> 90.0%	> 91.0%
Max. output efficiency <sup>②</sup>	> 92.0% (40% loads)	> 92.5% (30% loads)	> 92.5% (40% loads)
Idle current	< 0.2A	< 0.15A	< 0.1A
No-load current	< 0.8A	< 0.6A	< 0.5A
USB output	5VDC/Max.1A		--
RS485 com. port	5VDC/200mA		
<b>Mechanical parameters</b>			
Input terminal	M6		M6



Dimension (L x W x H)	371 × 231.5 × 123mm	332×231.5×123mm
Mounting size (L x W)	345 × 145mm	306×145mm
Mounting hole size	Φ6mm	Φ6mm
Net Weight	5.0kg	4.5kg

① It is measured in the condition of continuous output power and rated input voltage.

② It means the max. output efficiency when the inverter is connected with different loads under the rated input voltage.

Parameters	IP1500-11-Plus	IP1500-21-Plus	IP1500-41-Plus
Continuous output power	1500W@35°C@ Rated input voltage		
Surge power	3000W@5S		
Surge current when power on	< 100A		< 50A
Output voltage	100VAC/110VAC (±3%); 120VAC (-7%~+3%)		
Output frequency	50/60Hz ± 0.2%		
Output wave	Pure Sine Wave		
Output distortion THD	THD ≤ 4% (Resistive load)		
Load power factor	0.2~1(Load power ≤ Continuous output power)		
Rated input voltage	12VDC	24VDC	48VDC
Input voltage range	10.8~16.0VDC	21.6~32.0VDC	43.2~64.0VDC
Rated output efficiency <sup>①</sup>	> 88.0%	> 88.0%	> 90.0%
Max. output efficiency <sup>②</sup>	> 93.0% (30% loads)	> 92.5% (30% loads)	> 92.0% (30% loads)
Idle current	< 0.2A	< 0.15A	< 0.1A
No-load current	< 1.0A	< 0.9A	< 0.5A
USB output	5VDC/Max.1A		---
RS485 com. port	5VDC/200mA		
<b>Mechanical parameters</b>			
Input terminal	M6		

Dimension (L x W x H)	387 × 231.5 × 123mm
Mounting size (L x W)	361 × 145mm
Mounting hole size	Φ6mm
Net Weight	6.0kg

① It is measured in the condition of continuous output power and rated input voltage.

② It means the max. output efficiency when the inverter is connected with different loads under the rated input voltage.

Parameters	IP2000-11-Plus	IP2000-21-Plus	IP2000-41-Plus
Continuous output power	2000W@35°C@ Rated input voltage		
Surge power	4000W@5S		
Surge current when power on	< 100A	< 100A	< 50A
Output voltage	100VAC/110VAC (±3%); 120VAC (-7%~+3%)		
Output frequency	50/60Hz ± 0.2%		
Output wave	Pure Sine Wave		
Output distortion THD	THD ≤ 5% (Resistive load)	THD ≤ 4% (Resistive load)	THD ≤ 4% (Resistive load)
Load power factor	0.2 ~ 1 (Load power ≤ Continuous output power)		
Rated input voltage	12VDC	24VDC	48VDC
Input voltage range	10.8 ~ 16.0VDC	21.6 ~ 32.0VDC	43.2 ~ 64.0VDC
Rated output efficiency <sup>①</sup>	> 85.0%	> 88.0%	> 88.0%
Max. output efficiency <sup>②</sup>	> 92.0% (30% loads)	> 92.0% (30% loads)	> 93.0% (30% loads)
Idle current	< 0.2A	< 0.15A	< 0.1A
No-load current	< 1.2A	< 0.9A	< 0.5A
USB output	5VDC/Max.1A	5VDC/ Max.1A	---
RS485 com. port	5VDC/ 200mA		
Mechanical parameters			
Input terminal	M10	M6	

Dimension (L x W x H)	420 × 231.5 × 123mm	421 × 231.5 × 123mm
Mounting size (L x W)	395 × 145mm	395 × 145mm
Mounting hole size	Φ6mm	Φ6mm
Net Weight	8.0kg	6.5kg

① It is measured in the condition of continuous output power and rated input voltage.

② It means the max. output efficiency when the inverter is connected with different loads under the rated input voltage.

Parameters	IP3000-11-Plus	IP3000-21-Plus	IP3000-41-Plus	IP4000-41-Plus
Continuous output power	3000W@35°C@Rated input voltage			4000W@35°C@Rated input voltage
Surge power	4800W@5S	6000W@5S	6000W@5S	8000W@5S
Surge current when power on	< 100A	< 100A	< 65A	< 65A
Output voltage	100VAC/110VAC (±3%); 120VAC (-7%~+3%)			
Output frequency	50/60Hz ± 0.2%			
Output wave	Pure Sine Wave			
Output distortion THD	THD ≤ 4% (Resistive load)	THD ≤ 5% (Resistive load)	THD ≤ 4% (Resistive load)	THD ≤ 4% (Resistive load)
Load power factor	0.2 ~ 1 (Load power ≤ Continuous output power)			
Rated input voltage	12VDC	24VDC	48VDC	48VDC
Input voltage range	10.8 ~ 16.0VDC	21.6 ~ 32.0VDC	43.2 ~ 64.0VDC	43.2 ~ 64VDC
Rated output efficiency <sup>①</sup>	> 85.0%	> 87.0%	> 89.5%	> 88.0%
Max. output efficiency <sup>②</sup>	> 93.0% (30% loads)	> 91.5% (30% loads)	> 93.5% (30% loads)	> 93.0% (30% loads)
Idle current	< 0.2A	< 0.15A	< 0.1A	< 0.1A
No-load current	< 1.6A	< 1A	< 0.4A	< 0.6A
USB output	5VDC/Max.1A	5VDC/Max.1A	---	---
RS485 com. port	5VDC/ 200mA			
<b>Mechanical parameters</b>				

Input terminal	M10	M6	M6	M6
Dimension (L x W x H)	550 × 274 × 148mm	521 × 274 × 148mm	516 × 231.5 × 123mm	521 × 274 × 148mm
Mounting size (L x W)	525 × 145mm	495 × 145mm	490 × 145mm	495 × 145mm
Mounting hole size	Φ6mm	Φ6mm	Φ6mm	Φ6mm
Net Weight	13.0kg	8.0kg	8.0kg	12.0kg

① It is measured in the condition of continuous output power and rated input voltage.

② It means the max. output efficiency when the inverter is connected with different loads under the rated input voltage.

### 220/230/240VAC output

Parameters	IP350-12-Plus	IP350-22-Plus	IP500-12-Plus	IP500-22-Plus
Continuous output power	350W@35°C@ Rated input voltage		500W@35°C@ Rated input voltage	
Surge power	700W@5S		1000W@5S	
Surge current when power on	< 30A		< 50A	
Output voltage	220VAC (±3%); 230VAC (-6%~+3%); 240VAC (-9%~+3%)			
Output frequency	50/60Hz ± 0.2%			
Output wave	Pure Sine Wave			
Output distortion THD	THD ≤ 3% (Resistive load)			
Load power factor	0.2 ~ 1 (Load power ≤ Continuous output power)			
Rated input voltage	12VDC	24VDC	12VDC	24VDC
Input voltage range	10.8 ~ 16.0VDC	21.6 ~ 32VDC	10.8 ~ 16.0VDC	21.6 ~ 32VDC
Rated output efficiency <sup>①</sup>	> 89.0%	> 90.0%	> 89.5%	> 91.5%
Max. output efficiency <sup>②</sup>	> 90.0% (70% loads)	> 91.5% (70% loads)	> 91.0% (40% loads)	> 92.0% (40% loads)
Idle current	< 0.15A	< 0.10A	< 0.15A	< 0.10A
No-load current	< 0.9A	< 0.4A	< 0.9A	< 0.6A
USB output	5VDC/Max.1A			

RS485 com. port	5VDC/200mA	
<b>Mechanical parameters</b>		
Input terminal	M6	M6
Dimension (L x W x H)	229 × 163.5 × 75mm (with decorative cover) 229 × 160 × 73mm (without decorative cover)	286 × 163.5 × 78mm (with decorative cover) 286 × 160 × 78mm (without decorative cover)
Mounting size (L x W)	205 × 75mm	262 × 75mm
Mounting hole size	Φ5mm	Φ5mm
Net Weight	1.5Kg	2.3kg

① It is measured in the condition of continuous output power and rated input voltage.

② It means the max. output efficiency when the inverter is connected with different loads under the rated input voltage.

Parameters	IP1000-12-Plus	IP1000-22-Plus	IP1000-42-Plus
Continuous output power	1000W@35°C@ Rated input voltage		
Surge power	2000W@5S		
Surge current when power on	< 100A		< 35A
Output voltage	220VAC (±3%); 230VAC (-6%~+3%); 240VAC (-9%~+3%)		220VAC/230VAC/240VAC(±3%)
Output frequency	50/60Hz ± 0.2%		
Output wave	Pure Sine Wave		
Output distortion THD	THD ≤ 3% (Resistive load)		
Load power factor	0.2 ~ 1 (Load power ≤ Continuous output power)		
Rated input voltage	12VDC	24VDC	48VDC
Input voltage range	10.8 ~ 16.0VDC	21.6 ~ 32.0VDC	43.2 ~ 64.0VDC
Rated output efficiency <sup>①</sup>	> 89.0%	> 90.0%	> 92.0%
Max. output efficiency <sup>②</sup>	> 93.0% (40% loads)	> 93.0% (30% loads)	> 93.0% (40% loads)
Idle current	< 0.2A	< 0.15A	< 0.1A
No-load current	< 1.1A	< 0.9A	< 0.4A

USB output	5VDC/Max.1A	--
RS485 com. port	5VDC/200mA	
<b>Mechanical parameters</b>		
Input terminal	M6	M6
Dimension (L x W x H)	371 x 231.5 x 123mm	332x231.5x123mm
Mounting size (L x W)	345 x 145mm	306x145mm
Mounting hole size	Φ6mm	Φ6mm
Net Weight	5.0kg	4.5Kg

① It is measured in the condition of continuous output power and rated input voltage.

② It means the max. output efficiency when the inverter is connected with different loads under the rated input voltage.

Parameters	IP1500-12-Plus	IP1500-22-Plus	IP1500-42-Plus
Continuous output power	1500W@35°C@ Rated input voltage		
Surge power	3000W@5S		
Surge current when power on	< 100A		< 50A
Output voltage	220VAC (±3%); 230VAC (-6%~+3%); 240VAC (-9%~+3%)		
Output frequency	50/60Hz ± 0.2%		
Output wave	Pure Sine Wave		
Output distortion THD	THD ≤ 3% (Resistive load)		
Load power factor	0.2 ~ 1 (Load power ≤ Continuous output power)		
Rated input voltage	12VDC	24VDC	48VDC
Input voltage range	10.8 ~ 16.0VDC	21.6 ~ 32.0VDC	43.2 ~ 64.0VDC
Rated output efficiency <sup>①</sup>	> 89.0%	> 90.0%	> 92.5%
Max. output efficiency <sup>②</sup>	> 93.0% (30% loads)	> 93.5% (30% loads)	> 94.0% (30% loads)
Idle current	< 0.2A	< 0.15A	< 0.1A
No-load current	< 1.2A	< 0.9A	< 0.5A

USB output	5VDC/Max.1A	---
RS485 com. port	5VDC/200mA	
<b>Mechanical parameters</b>		
Input terminal	M6	
Dimension (L x W x H)	387 × 231.5 × 123mm	
Mounting size (L x W)	361 × 145mm	
Mounting hole size	Φ6mm	
Net Weight	6.0kg	

① It is measured in the condition of continuous output power and rated input voltage.

② It means the max. output efficiency when the inverter is connected with different loads under the rated input voltage.

Parameters	IP2000-12-Plus	IP2000-22-Plus	IP2000-42-Plus
Continuous output power	2000W@35°C@ Rated input voltage		
Surge power	4000W@5S		
Surge current when power on	< 100A	< 100A	< 50A
Output voltage	220VAC (±3%); 230VAC (-6%~+3%); 240VAC (-9%~+3%)		
Output frequency	50/60Hz ± 0.2%		
Output wave	Pure Sine Wave		
Output distortion THD	THD ≤ 3% (Resistive load)		
Load power factor	0.2 ~ 1 (Load power ≤ Continuous output power)		
Rated input voltage	12VDC	24VDC	48VDC
Input voltage range	10.8 ~ 16.0VDC	21.6 ~ 32.0VDC	43.2 ~ 64.0VDC
Rated output efficiency <sup>①</sup>	> 88.0%	> 90.0%	> 92.5%
Max. output efficiency <sup>②</sup>	> 94.0% (30% loads)	> 93.0% (30% loads)	> 94.5% (30% loads)
Idle current	< 0.2A	< 0.15A	< 0.1A
No-load current	< 1.2A	< 1.0A	< 0.5A

USB output	5VDC/Max.1A	5VDC/ Max.1A	---
RS485 com. port	5VDC/ 200mA		
<b>Mechanical parameters</b>			
Input terminal	M10	M6	
Dimension (L x W x H)	420 x 231.5 x 123mm	421 x 231.5 x 123mm	
Mounting size (L x W)	395 x 145mm	395 x 145mm	
Mounting hole size	Φ6mm	Φ6mm	
Net Weight	8.0kg	6.5kg	

① It is measured in the condition of continuous output power and rated input voltage.

② It means the max. output efficiency when the inverter is connected with different loads under the rated input voltage.

Parameters	IP3000-12-Plus	IP3000-22-Plus	IP3000-42-Plus	IP4000-42-Plus	IP5000-42-Plus
Continuous output power	3000W@35°C@Rated input voltage			4000W@35°C@Rated input voltage	5000W@35°C@Rated input voltage
Surge power	6000W@5S			8000W@5S	8000W@5S
Surge current when power on	< 100A	< 100A	< 65A	< 65A	< 65A
Output voltage	220VAC (±3%); 230VAC (-6%~+3%); 240VAC (-9%~+3%)				
Output frequency	50/60Hz ± 0.2%				
Output wave	Pure Sine Wave				
Output distortion THD	THD ≤ 3% (Resistive load)				
Load power factor	0.2 ~ 1 (Load power ≤ Continuous output power)				
Rated input voltage	12VDC	24VDC	48VDC	48VDC	48VDC
Input voltage range	10.8 ~ 16.0VDC	21.6 ~ 32.0VDC	43.2 ~ 64.0VDC	43.2 ~ 64VDC	43.2 ~ 64.0VDC
Rated output efficiency <sup>①</sup>	> 87.0%	> 90.0%	> 92.5%	> 91.0%	> 91.0%
Max. output efficiency <sup>②</sup>	> 94.0%	> 94.0%	> 94.5%	> 94.0%	> 94.0%



	(30% loads)	(30% loads)	(30% loads)	(30% loads)	(30% loads)
Idle current	< 0.2A	< 0.15A	< 0.1A	< 0.1A	< 0.1A
No-load current	< 1.6A	< 1.0A	< 0.5A	< 0.6A	< 0.8A
USB output	5VDC/Max.1A	5VDC/Max.1A	---	---	---
RS485 com. port	5VDC/ 200mA				
<b>Mechanical parameters</b>					
Input terminal	M10	M6	M6	M6	M6
Dimension (L x W x H)	557 × 231.5 × 123mm	521 × 274 × 148mm	491 × 231.5 × 123mm	516 × 231.5 × 123mm	531 × 231.5 × 123mm
Mounting size (L x W)	532 × 145mm	495 × 145mm	465 × 145mm	490 × 145mm	505 × 145mm
Mounting hole size	Φ6mm	Φ6mm	Φ6mm	Φ6mm	Φ6mm
Net Weight	10.5kg	8.0kg	7.0kg	8.0kg	9.0kg

① It is measured in the condition of continuous output power and rated input voltage.

② It means the max. output efficiency when the inverter is connected with different loads under the rated input voltage.

Environment parameters		Certification	
Environment temperature	-20°C ~ +60°C (Refer to the <i>Derating Curve</i> )	Safety	EN/IEC62109-1, UL1741, UL458, CSA C22.2#107.1
Storage temperature	-35°C ~ +70°C	EMC(Electromagnetic compatibility)	EN61000-6-1/EN61000-6-3 FCC 47 CFR Part 15, Subpart B
Relative humidity	< 95% (N.C.)	RoHS	IEC62321-3-1
Enclosure	IP20	--	
Altitude	< 5000m (If the altitude exceeds 1000 meters, the rated power will be reduced according to IEC62040.)		

# Appendix 1 Disclaimers

**The warranty does not apply to the following conditions:**

- Damage is caused by improper use or an inappropriate environment (humid, salt spray, corrosion, greasy, flammable, explosive, dust accumulative, or other severe environments).
- The actual current/voltage/power exceeds the limit value of the inverter.
- Damage caused by working temperature exceeds the rated range.
- Arc, fire, explosion, and other accidents are caused by failure to follow the inverter stickers or manual instructions.
- Disassemble and repair the inverter without authorization.
- Damage caused by force majeure.
- Damage occurred during transportation or handling.
- Before using precise instruments, such as a medical instrument, end-users must read the manual carefully and ensure the inverter's output power/output voltage is suitable. We are not responsible for the instrument damage caused by improper use.

**Any changes without prior notice! Version number: V3.2**



**HUIZHOU EPEVER TECHNOLOGY CO., LTD.**

**Tel: +86-752-3889706**

**E-mail: [info@epever.com](mailto:info@epever.com)**

**Website: [www.epever.com](http://www.epever.com)**